

**READ AND SAVE THESE INSTRUCTIONS**

# OPERATION MANUAL

Surface evaporator  
Condair **ME Control**

# Thank you for choosing Condair

Installation date (MM/DD/YYYY):

Commissioning date (MM/DD/YYYY):

Location ref.:

Model:

Serial number:

## Proprietary Notice

This document and the information disclosed herein are proprietary data of Condair Group AG. Neither this document, nor the information contained herein shall be reproduced, used, or disclosed to others without the written authorization of Condair Group AG, except to the extent required for installation or maintenance of recipient's equipment.

## Liability Notice

Condair Group AG does not accept any liability due to incorrect installation or operation of the equipment or due to the use of parts/components/equipment that are not authorized by Condair Group AG.

## Copyright Notice

© Condair Group AG, All rights reserved.

Technical modifications reserved

# Contents

<b>1</b>	<b>Introduction</b>	<b>5</b>
1.1	General	5
1.2	Notes on the operation manual	5
<b>2</b>	<b>For your safety</b>	<b>7</b>
<b>3</b>	<b>Product Overview</b>	<b>10</b>
3.1	Model overview	10
3.2	Product designation / Which model do you have	11
3.3	Construction of the system components	12
3.3.1	Construction of the evaporative module	12
3.3.2	Construction of the hydraulic module	13
3.4	System overviews / Functional description	14
3.4.1	Typical system Condair ME Control, internal install	14
3.4.2	Typical system Condair ME Control, external install with centre drain tank	15
3.4.3	Typical system Condair ME Control, external install with side drain tank (evaporative modules up to 3000 mm wide only)	16
3.4.4	Schematic flow diagrams	17
<b>4</b>	<b>Operation</b>	<b>19</b>
4.1	Important notes on operation	19
4.2	Initial commissioning	20
4.3	Display and operating elements	22
4.4	Start up for normal operation	23
4.5	Notes on operation	24
4.5.1	Important notes on operation	24
4.5.2	Remote operating and fault indication (option)	24
4.5.3	Recommended regular checks during operation	24
4.5.4	Draining of the water tank	25
4.5.5	Performing a matrix wash over	26
4.6	Decommissioning the system	27
<b>5</b>	<b>Operating the Condair ME control software</b>	<b>28</b>
5.1	Standard operating display	28
5.1.1	Operating status indication	29
5.1.2	Maintenance and malfunction indications	30
5.2	Navigating/operating the Condair ME control software	31
5.3	Information functions	32
5.3.1	Accessing support information	32
5.3.2	Accessing system information	32
5.4	Configuration	36
5.4.1	Accessing the "Configuration" submenu	36
5.4.2	Control settings – "Control Settings" submenu	37
5.4.3	Basic settings – "General" submenu	40
5.4.4	Communication settings – "Communication" submenu	41

5.5	Service functions	44
5.5.1	Accessing the "Service" submenu	44
5.5.2	Performing maintenance functions – "Service" submenu	44
5.5.2.1	Input diagnostic functions – "Input Diagnostics" submenu	46
5.5.2.2	Relay diagnostic functions – "Relay Diagnostics" submenu	48
5.6	Administration settings	49
5.6.1	Accessing "Administrator" submenu	49
5.6.2	Administration settings – "Administrator" submenu	49
<b>6</b>	<b>Maintenance</b>	<b>51</b>
6.1	Important notes on maintenance	51
6.2	Maintenance intervals	52
6.3	Maintenance guide	53
6.4	Dismantling and installation of components for maintenance	54
6.4.1	Dismantling and installation of the evaporative module	54
6.5	Consumables guide	55
6.6	Routine water sampling and hygiene checks	55
6.7	Cleaning and disinfection	55
6.8	Cleaning and disinfection procedure	56
6.9	Resetting the maintenance indication on Condair ME Control	58
6.10	Performing software and firmware updates	59
<b>7</b>	<b>Fault elimination</b>	<b>60</b>
7.1	Fault indication on Condair ME Control control unit	60
7.2	Malfunction list	61
7.3	Saving fault and service histories to a USB memory stick	67
7.4	Malfunctions without indication	67
7.5	Notes on fault elimination	68
7.6	Resetting the fault status on Condair ME Control	68
7.7	Replacing the fuses and backup battery in the control unit	69
<b>8</b>	<b>Taking out of service/Disposal</b>	<b>70</b>
8.1	Taking out of service	70
8.2	Disposal/Recycling	70
<b>9</b>	<b>Product specifications</b>	<b>71</b>
9.1	Technical data	71
<b>10</b>	<b>Appendix</b>	<b>72</b>
10.1	Wiring diagram Condair ME Control	72

# 1 Introduction

---

## 1.1 General

We thank you for having purchased the **Condair ME Control surface evaporator** (Condair ME Control for short).

To ensure a safe, proper, and economical operation of the Condair ME Control, please observe and comply with all information and safety instructions contained in the present documentation as well as in the separate documentations of the components installed in the surface evaporator. Improper use of the Condair ME Control may result in danger to the user or third parties and/or impairment of material assets.

If you have questions after reading this documentation, please contact your Condair representative. They will be glad to assist you.

## 1.2 Notes on the operation manual

### Limitation

**The subject of this operation manual is the Condair ME Control surface evaporator.** The various options and accessories are only described insofar as is necessary for proper operation of the equipment. Further information on options and accessories can be obtained in the respective instructions.

This operation manual is restricted to the **commissioning**, the **operation**, the **maintenance** and **troubleshooting** of the Condair ME Control and is meant for **well trained personnel being sufficiently qualified for their respective work**.

Please note, some illustrations in this manual may show options and accessories which may not be supplied as standard. Please check availability and specification details with your Condair representative.

The operation manual is supplemented by various separate items of documentation (such as the installation manual), which are included in the delivery as well. Where necessary, appropriate cross-references are made to these publications in the operation manual.

## Symbols used in this manual



### CAUTION!

The catchword "CAUTION" used in conjunction with the caution symbol in the circle designates notes in this operation manual that, if neglected, may cause **damage and/or malfunction of the unit or other material assets**.



### WARNING!

The catchword "WARNING" used in conjunction with the general caution symbol designates safety and danger notes in this operation manual that, if neglected, may cause **injury to persons**.



### DANGER!

The catchword "DANGER" used in conjunction with the general caution symbol designates safety and danger notes in this operation manual that, if neglected, may lead to **severe injury or even death of persons**.

## Safekeeping

Please safeguard this operation manual in a safe place, where it can be immediately accessed. If the equipment changes hands, the operation manual must be passed on to the new operator.

If the operation manual gets mislaid, please contact your Condair representative.

## Language versions

This operation manual is available in various languages. Please contact your Condair representative for information.

## 2 For your safety

---

### General

Every person working with the Condair ME Control must have read and understood the operation manual of the Condair ME Control before carrying out any work.

Knowing and understanding the contents of the operation manual is a basic requirement for protecting the personnel against any kind of danger, to prevent faulty operation, and to operate the unit safely and correctly.

All ideograms, signs and markings applied to the components of the Condair ME Control must be observed and kept in readable state.

### Qualification of personnel

All work described in this operation manual **may only be carried out by specialists who are well trained and adequately qualified and are authorized by the customer.**

For safety and warranty reasons any action beyond the scope of this manual must only be carried out by personnel with appropriate industry recognised qualifications or training.

It is assumed that all persons working with the Condair ME Control are familiar and comply with the appropriate local regulations on work safety and the prevention of accidents.

The Condair ME Control may not be used by persons (including children) with reduced physical, sensory or mental abilities or persons with lacking experience and/or knowledge, unless they are supervised by a person responsible for their safety or they received instructions on how to operate the system.

Children must be supervised to make sure that they do not play with the Condair ME Control.

### Intended use

The Condair ME Control is intended exclusively for **outlet air cooling in AHU's or air ducts** within the specified operating conditions. Any other type of application, without the written consent of the manufacturer, is considered as not conforming with the intended purpose and may lead to the Condair ME Control becoming dangerous.

Operation of the equipment in the intended manner requires **that all the information contained in this operation manual are observed (in particular the safety instructions).**

## Danger that may arise from the Condair ME Control



**DANGER!**  
Risk of electric shock!

The Condair ME Control unit (and the optional submerged UV system) contain live mains voltage. Live parts may be exposed when the control unit (or the terminal box of the optional submerged UV system) is open. Touching live parts may cause severe injury or danger to life.

**Prevention:** Before carrying out any work on the Condair ME Control switch off the control unit, disconnect it from the mains via the electrical isolator and secure the electrical isolator in "Off" position against inadvertent power-up.



**DANGER!**  
Health risk because of inadequate hygiene!

Inadequately operated and/or poorly maintained surface evaporator may endanger health. When inadequately operated and/or poorly maintained micro-organisms may grow in the evaporative module, the water tank and the water system of the Condair ME Control and may affect the air in the AHU/air duct.

**Prevention:** the Condair ME Control must strictly be operated and maintained in accordance with this manual.



**WARNING!**

Some types of evaporative material are manufactured from glass fibre. Though this material is not classified as hazardous, it is recommended that Personal Protection Equipment such as gloves, protective clothing and eye protection are used during handling to protect the user from fibres or dust. If dust is generated during handling it is recommended that respiratory protection is worn.

### Correct lifting and handling

Lifting or handling of components always carries an element of risk, and therefore must only be carried out by trained and qualified personnel. Ensure that any lifting operations have been fully planned and risk assessed. All equipment should be checked by a skilled and competent health & safety representative.

It is the customer's responsibility to ensure that operators are trained in handling heavy goods and to enforce the relevant lifting regulations.



### **Preventing unsafe operation**

If it is suspected that **safe and hygienic operation is no longer possible**, then the Condair ME Control should immediately **be shut down and secured against accidental power-up according to [chapter 4.6](#)**. This can be the case under the following circumstances:

- if the Condair ME Control is damaged
- if the Condair ME Control is contaminated
- if the electrical installations are damaged
- if the Condair ME Control is no longer operating correctly
- if connections and/or piping are leaking

All persons working with the Condair ME Control must report any alterations to the system that may affect safety to the owner without delay.

### **Prohibited modifications to the unit**

**No modifications must be undertaken** on the Condair ME Control without the express written consent of the manufacturer.

For the replacement of defective components use exclusively **original accessories and spare parts** available from your Condair representative.

## 3 Product Overview

---

### 3.1 Model overview

As **standard** the **Condair ME Control** consist of:

- Evaporative module (85 % or 95 % efficiency depending on the cassette type)
- One hydraulic module which is mounted internal or external to the AHU/air duct.
- Control unit with integrated controller with touch panel

According to your order the Condair ME Control can be equipped with the following **options**:

- Droplet separator
- Evaporative module blanking
- Hydraulic module cover
- Remote operation and fault indication
- BTL Certified BACnet connectivity
- LonWorks connectivity
- Freeze protection stat
- Leak detection
- Conductivity monitoring
- Submerged UV
- Dosing pump
- Disinfection pump
- Install kit

### 3.2 Product designation / Which model do you have

The product designation and the most important unit data (e.g. serial number, evaporative module product key, etc.) are found on the rating plates toward the end of the evaporative module and on the right side of the control unit.

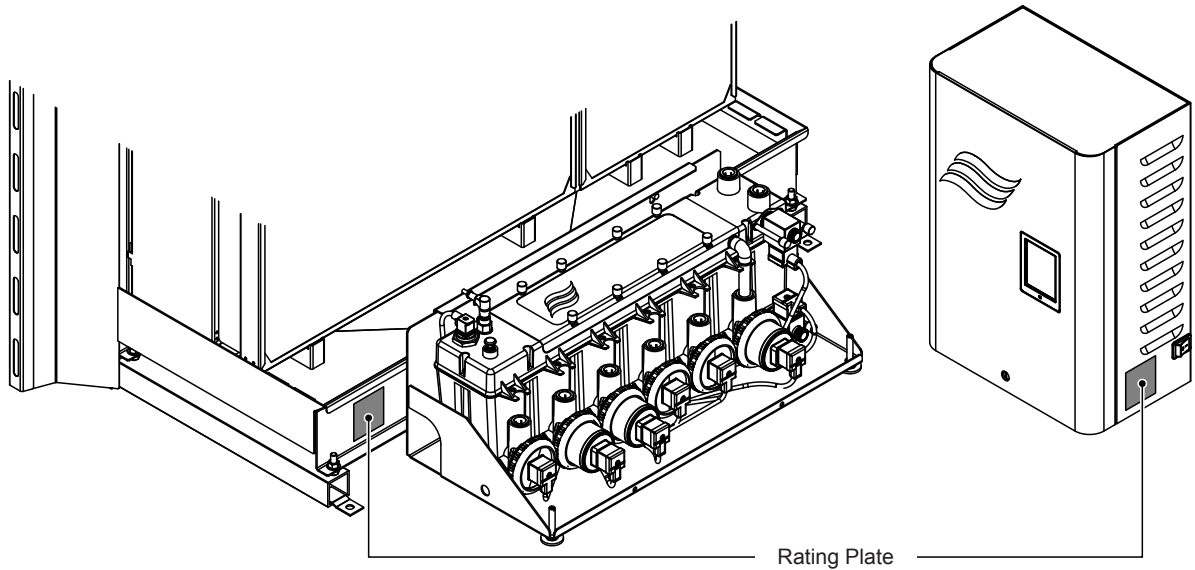

Fig. 1: Position of rating plate

#### Evaporative module product key

Product identification \_\_\_\_\_

**ME** (media evaporator)

Tank spigot position: \_\_\_\_\_

**C**= Center  
**L**= Left (for systems with evaporative modules ≤3000 mm wide only)  
**R**= Right (for systems with evaporative modules ≤3000 mm wide only)

Tank spigot diameter: \_\_\_\_\_

**S** = Small = ø50 mm

**Width** evaporative module in mm \_\_\_\_\_

Tank type: \_\_\_\_\_

**S** = Single spigot tank

**Height** evaporative module in mm \_\_\_\_\_

Material type and efficiency evaporative cassettes: \_\_\_\_\_

**P85**= Polyester 85 %  
**P95**= Polyester 95 %  
**C85**= C-Type Glass fibre 85 %  
**C95**= C-Type Glass fibre 95 %

Example:  
**ME-CS0900S-1125-F95**

### 3.3 Construction of the system components

#### 3.3.1 Construction of the evaporative module

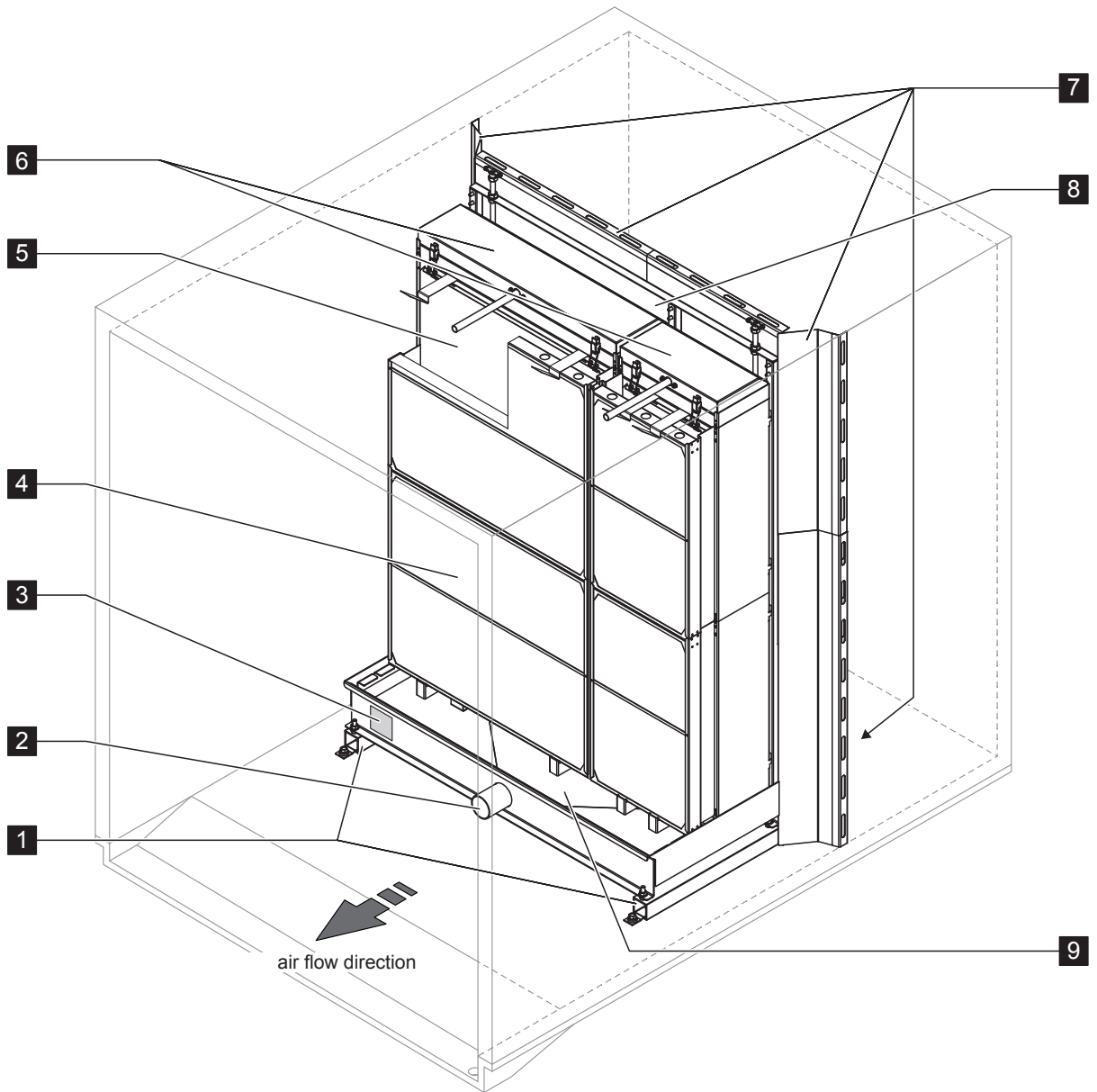

- |   |   |
|---|---|
| 1 Upstands  | 6 Distribution heads  |
| 2 Tank connector $\varnothing 50$ mm                                  | 7 Blanking plates (option, may differ in the look from the drawing shown above) |
| 3 Rating plate  | 8 Mounting frame for evaporative cassettes                                      |
| 4 Droplet separator, mandatory for high face velocities up to 4.5 m/s | 9 Water tank  |
| 5 Evaporative cassettes (P85, P95, C85 or C95)                        |   |

Fig. 2: Construction of the evaporative module

### 3.3.2 Construction of the hydraulic module

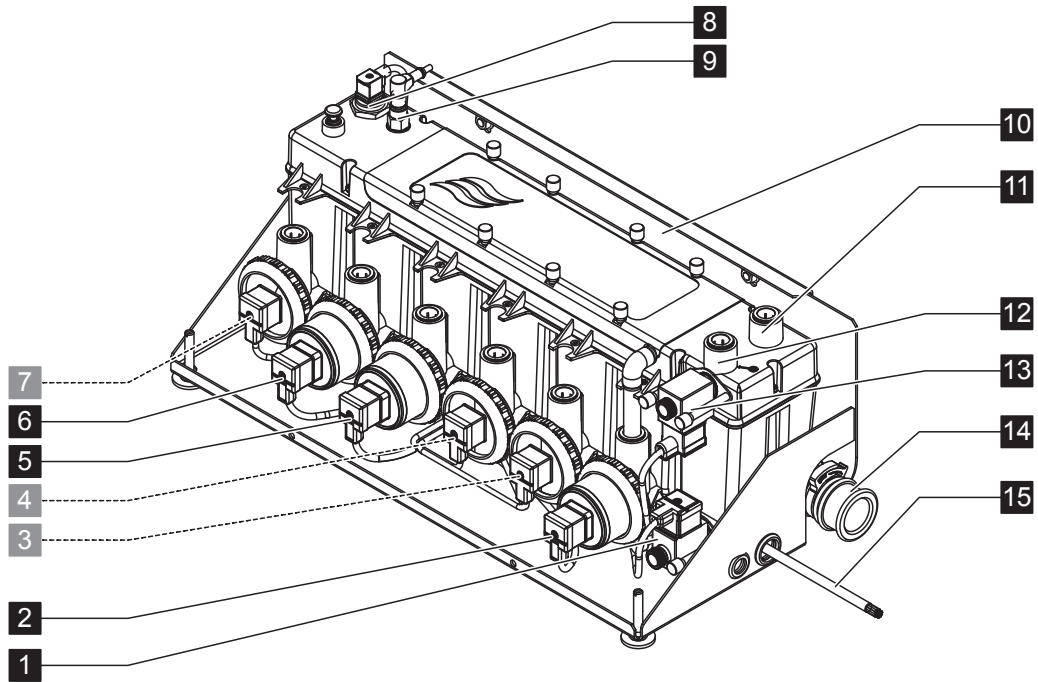

- |  |  |
|--|--|
| 1 Drain valve (normally open)                              | 11 Push-fit connector ( $\varnothing 15$ mm) for pressure equalisation (only used when mounted outside of AHU)       |
| 2 Drain pump   | 12 Water supply push-fit connector $\varnothing 15$ mm (module is supplied with a connecting hose that inserts here) |
| 3 Stage pump 5 with push-fit connector $\varnothing 15$ mm | 13 Inlet valve (normally closed)   |
| 4 Stage pump 3 with push-fit connector $\varnothing 15$ mm | 14 Drain connector $\varnothing 32$ mm   |
| 5 Stage pump 1 with push-fit connector $\varnothing 15$ mm | Note: the drain connector can be rotated to drain to the left, or the right, or down.                                |
| 6 Stage pump 2 with push-fit connector $\varnothing 15$ mm | 15 Interconnecting cable hydraulic module  |
| 7 Stage pump 4 with push-fit connector $\varnothing 15$ mm |  |
| 8 Level sensor   |  |
| 9 Conductivity sensor (option)                             |  |
| 10 Fixing bracket  |  |

Fig. 3: Construction of the hydraulic module (figure shows layout for 2-stage control)

Note: systems with evaporative modules >3000 mm wide have two hydraulic modules.

### 3.4 System overviews / Functional description

#### 3.4.1 Typical system Condair ME Control, internal install

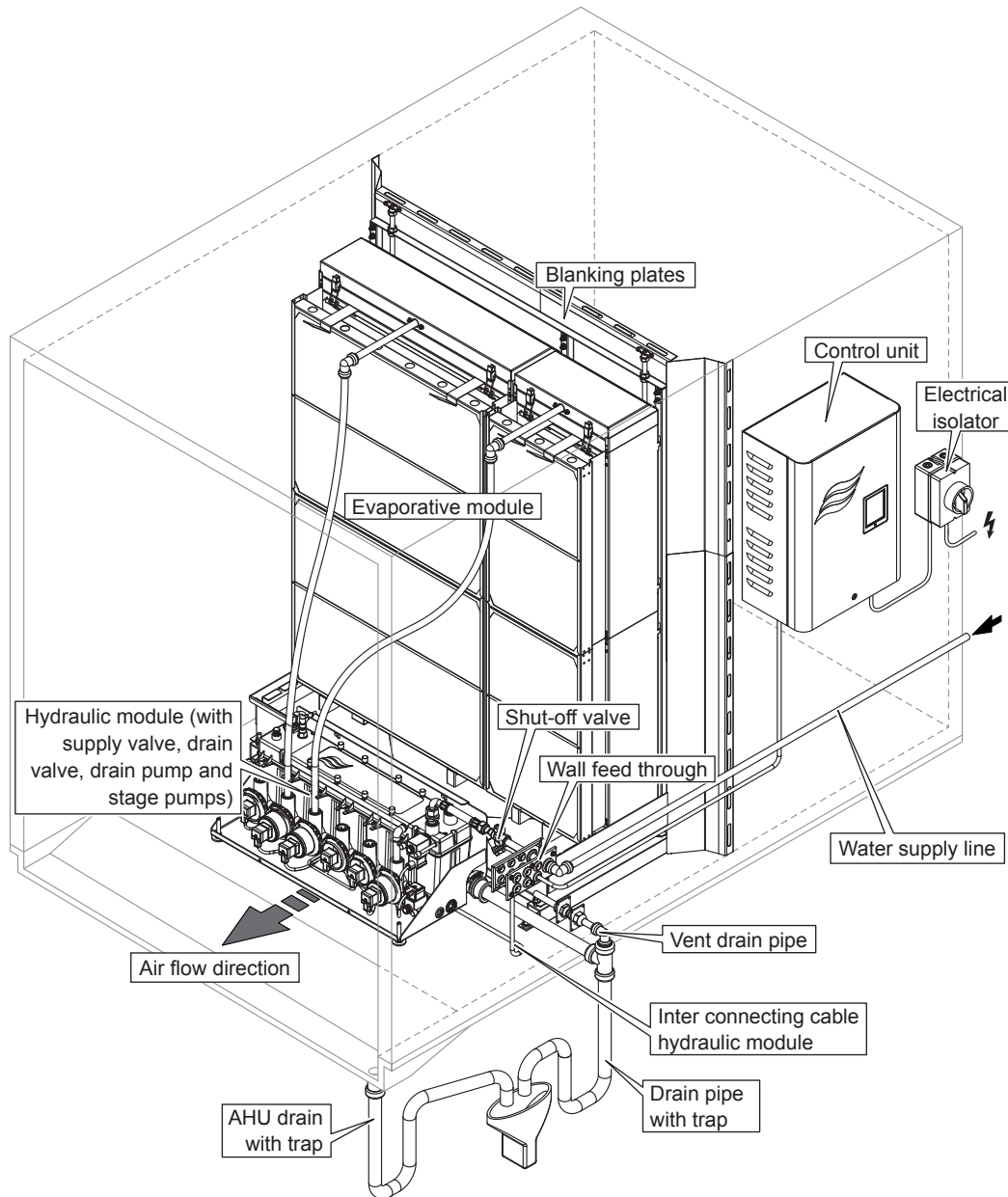

Fig. 4: Typical system Condair ME Control, internal install

### 3.4.2 Typical system Condair ME Control, external install with centre drain tank

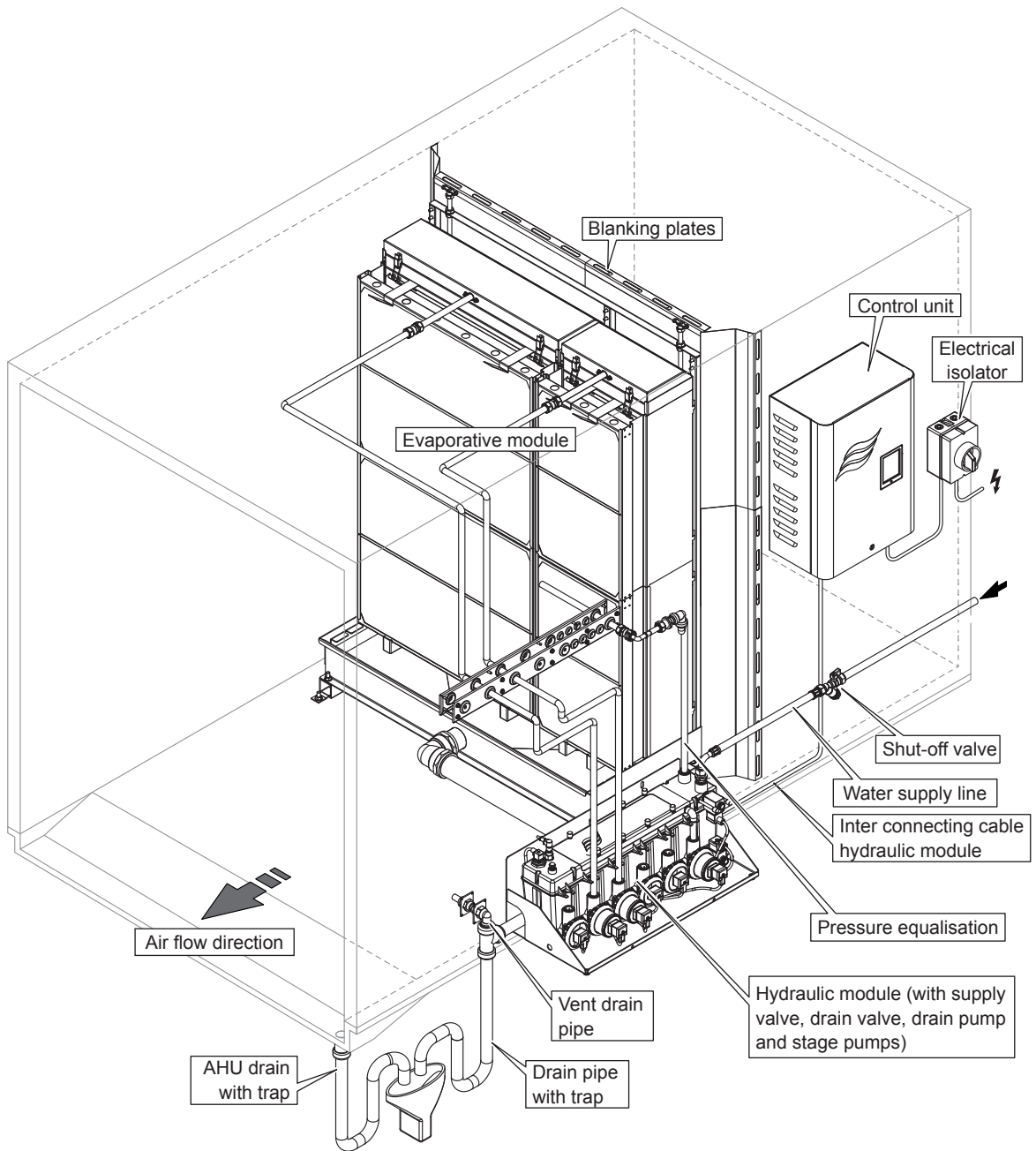

Fig. 5: Typical system Condair ME Control, external install with centre drain tank

### 3.4.3 Typical system Condair ME Control, external install with side drain tank (evaporative modules up to 3000 mm wide only)

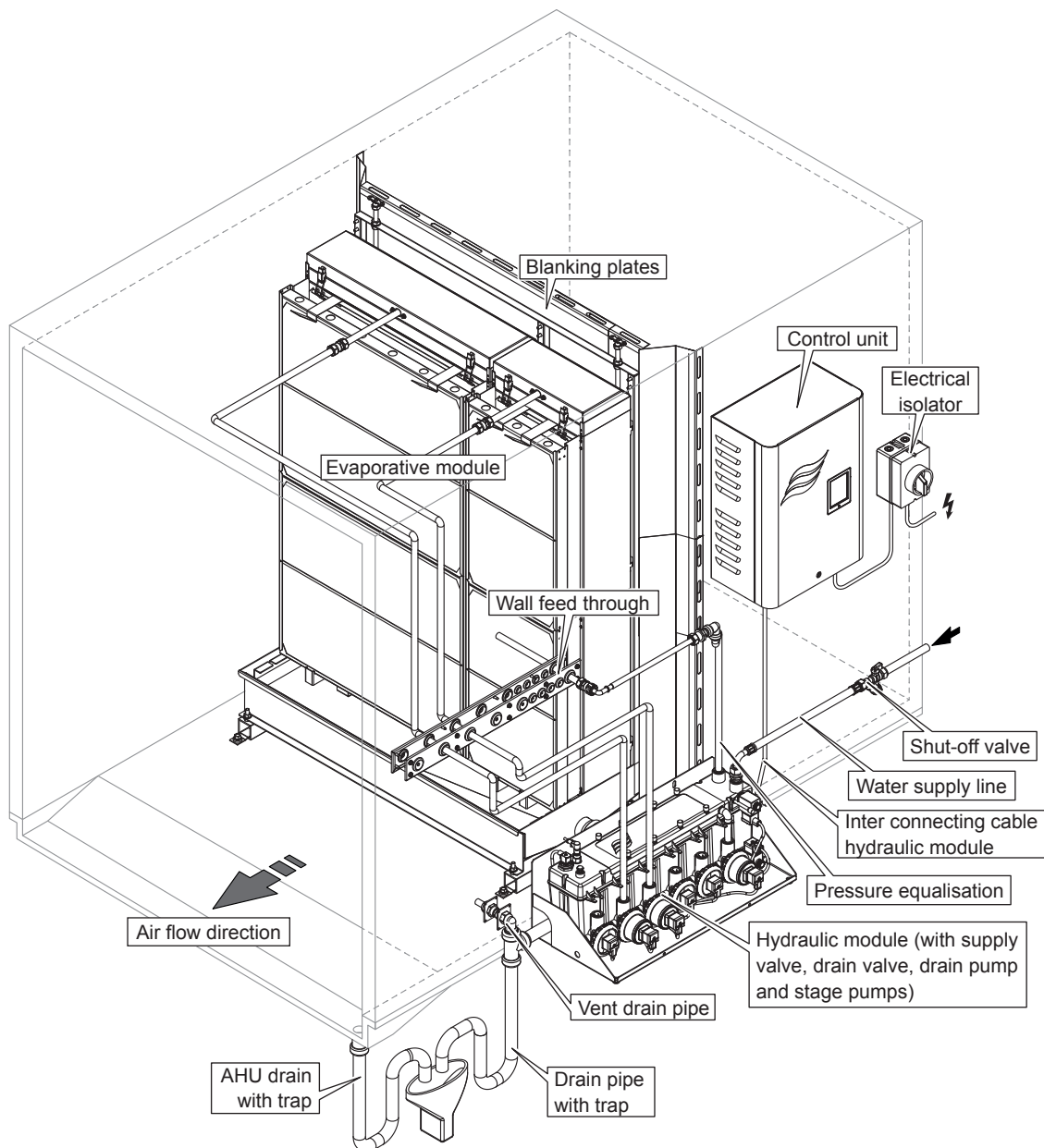

Fig. 6: Typical system Condair ME Control, external install with side drain tank (evaporative modules up to 3000 mm wide only)



### 3.4.4 Schematic flow diagrams

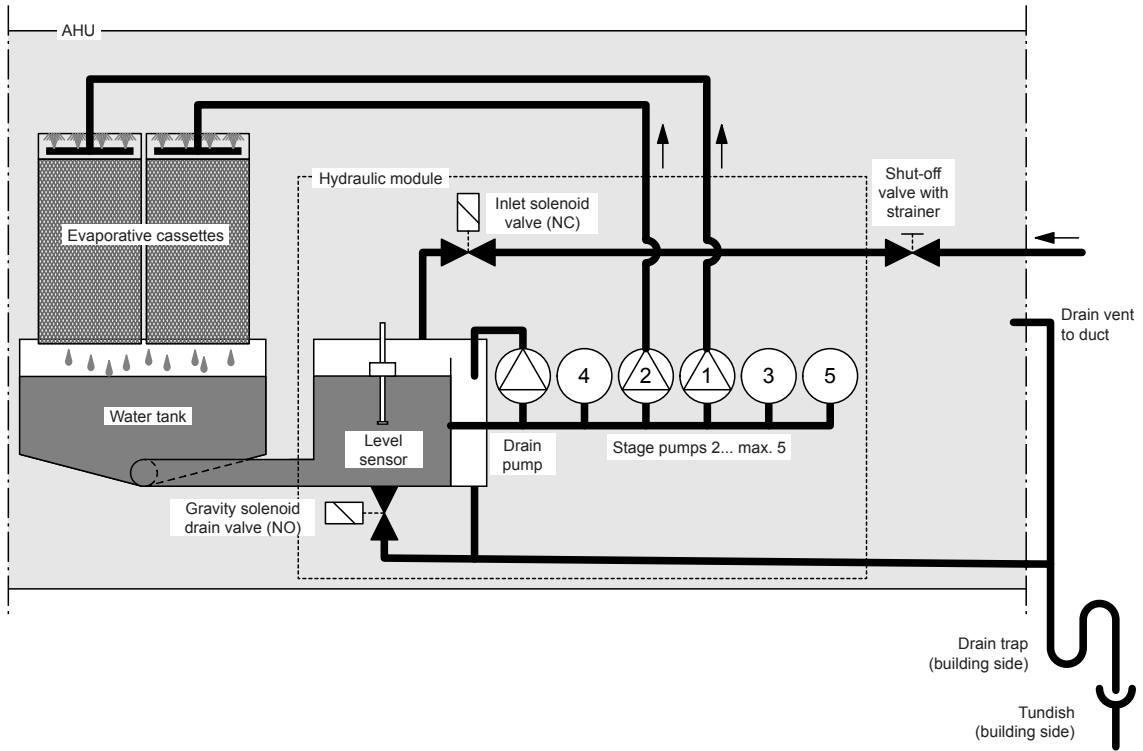

Fig. 7: Schematic flow diagram Condair ME Control (internally mounted)

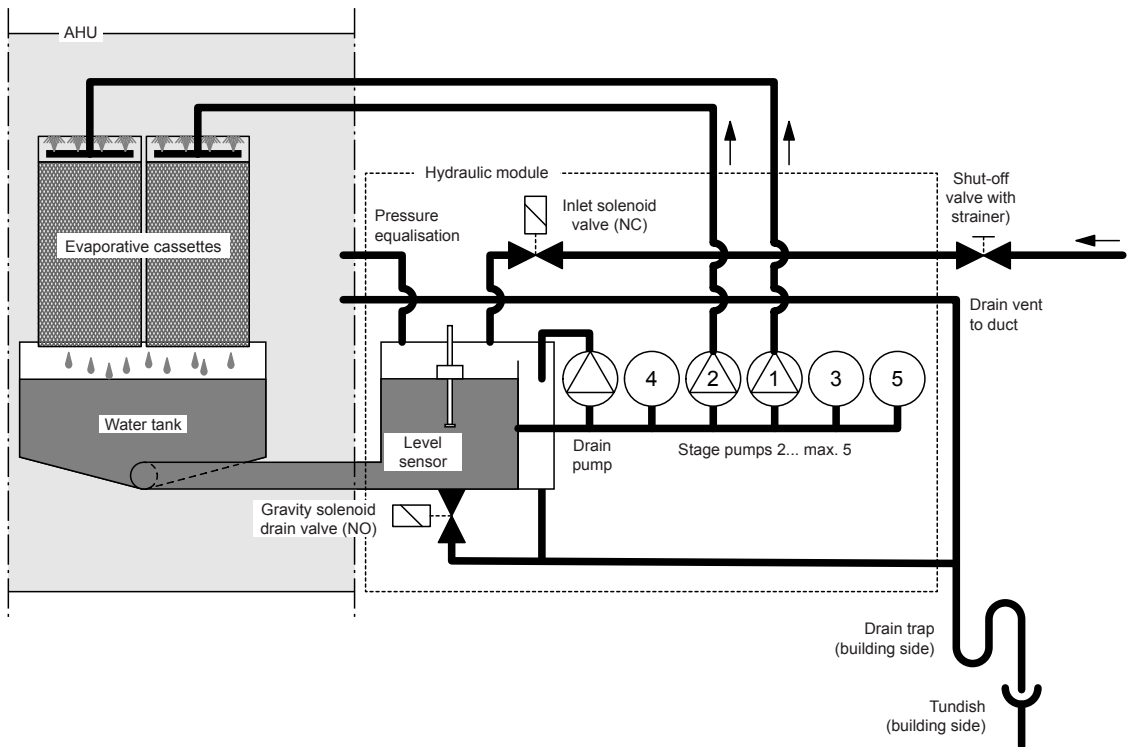

Fig. 8: Schematic flow diagram Condair ME Control (externally mounted)

## Functional description

The water tank is filled up to a preset upper level via the level-controlled inlet solenoid valve (NC). When the water level in the water tank drops below a certain limit, the level-controlled inlet solenoid valve opens until the upper limit is reached again.

The Condair ME Control provides On/Off or stage control by means of the Condair ME Control control unit and the stage pumps. The Condair ME Control control unit processes analog sensor/control signals and uses them to control the stage pumps.

In case of a cooling request with **activated On/Off control** the inlet solenoid valve (NC) opens and all stage pumps start and the water flows to the distribution headers above the evaporative cassettes.

In case of a cooling request with **activated stage control** the inlet solenoid valve (NC) opens, then depending on the demand signal and evaporative module size up to five stage pumps start and the water flows to the distribution headers above the evaporative cassettes.

The distribution pipes inside the distribution headers evenly supply the water to the entire surface of the evaporative cassettes where it flows down and cools the air flowing through the evaporative cassettes. The excess water not used for cooling flows to the water tank.

To prevent accumulation of mineral residues and the formation of germs in the water tank, the tank is completely drained periodically (interval or time controlled). Additionally further hygiene functions can be activated: Operation-dependent draining of the water tank (fill cycle, conductivity, temperature or time controlled).

# 4 Operation

---

## 4.1 Important notes on operation

### Qualification of personnel

The Condair ME Control must be commissioned and operated only by personnel familiar with the system and adequately qualified for the respective tasks. It is the owner's responsibility to verify proper qualification of the operating personnel.

### General notes

The instructions and details regarding commissioning and operation must be followed and upheld.

The initial commissioning of the Condair ME Control requires appropriately trained technical personnel. It is strongly recommended that your Condair representative commissions your system. Part of this initial commissioning process is a disinfection of the water tank, and if required the evaporative cassettes. Please read this document in full before commencing any work.

Please pay attention to local regulations regarding working at heights and electrical work.

### Safety and hygiene



**DANGER!**

**The Condair ME Control must be operated in accordance with this manual. Failure to do so could result in contamination of the system with micro-organisms.**

---



**WARNING!**

**The Condair ME control unit should not be electrically isolated for periods exceeding 24 hours as automatic drain and purge cycles will be disabled.**

---

## 4.2 Initial commissioning

The initial commissioning of the Condair ME Control requires appropriately trained technical personnel. We strongly recommend that your Condair representative commissions your system.

### Inspections

Prior to initial commissioning ensure Condair ME Control is correctly installed, connected and tight in accordance with the installation manual supplied.

### Commissioning

After the system has been inspected and found correct proceed with the initial commissioning:

1. Switch off AHU, and lock off to prevent AHU from starting.
2. Switch on electrical isolator, and then the **<Control unit On/Off>** switch on the control unit.
3. Simulate full demand and check components are operating correctly.
4. Check correct water level and pump activation.
5. Check water can flow to drain correctly.
6. Test correct flow of water to distribution header.
7. Test any fitted options (see relevant option addendum manual).
8. If the evaporative cassettes had become dirty or damp prior to commissioning, follow the disinfection procedure described in [chapter 6.3](#) and [chapter 6.8](#) of this manual.
9. If the system is equipped with fibre media evaporative cassettes (C85, C95) perform a matrix wash over cycle (see [chapter 5.5.2](#)).
10. Switch on fan of AHU and test operation with fans running and validate air conditions against the design data.
11. Test control devices.
12. Correctly configure Condair ME control unit (setpoints, control settings, etc.) according to the situation on site (see [chapter 5.4](#)).
13. Switch off AHU, and ensure AHU is locked-off to prevent it from starting.
14. Remove any demand from the ME system.
15. Drain the tank and wipe tank clean.
16. Perform disinfection:
  - Send a demand to the unit to make it fill and start running (the demand signal can be overridden for the duration of the disinfection using the "Disinfection Demand" function in the service menu (see [chapter 5.5.2](#)).
  - Set the duration of the disinfection period using the "Disinfection Duration" function in the service menu (see [chapter 5.5.2](#)). Ensure the disinfection period leaves sufficient time to neutralise the disinfectant if required.
  - Start disinfection process with the "Start Disinfection" function in the service menu (see [chapter 5.5.2](#)), to prevent the Condair ME Control draining the water tank during the disinfection process.
  - Add a disinfection chemical according to tank volume.
  - After the disinfection process has completed, neutralise disinfectant, if required.

17. Power cycle the Condair ME Control to remove the forced disinfection demand (allowing normal control to be resumed) and check correct control operations (signals, fault outputs, Modbus/BACnet).
18. Raise any installation concerns.
19. Record the commissioning and preserve commissioning documentation.  
Note: If commissioning has not been completed by an approved Condair representative, it is recommended that records are kept of commissioning date and software settings.

The system is now ready for normal operation.

## 4.3 Display and operating elements

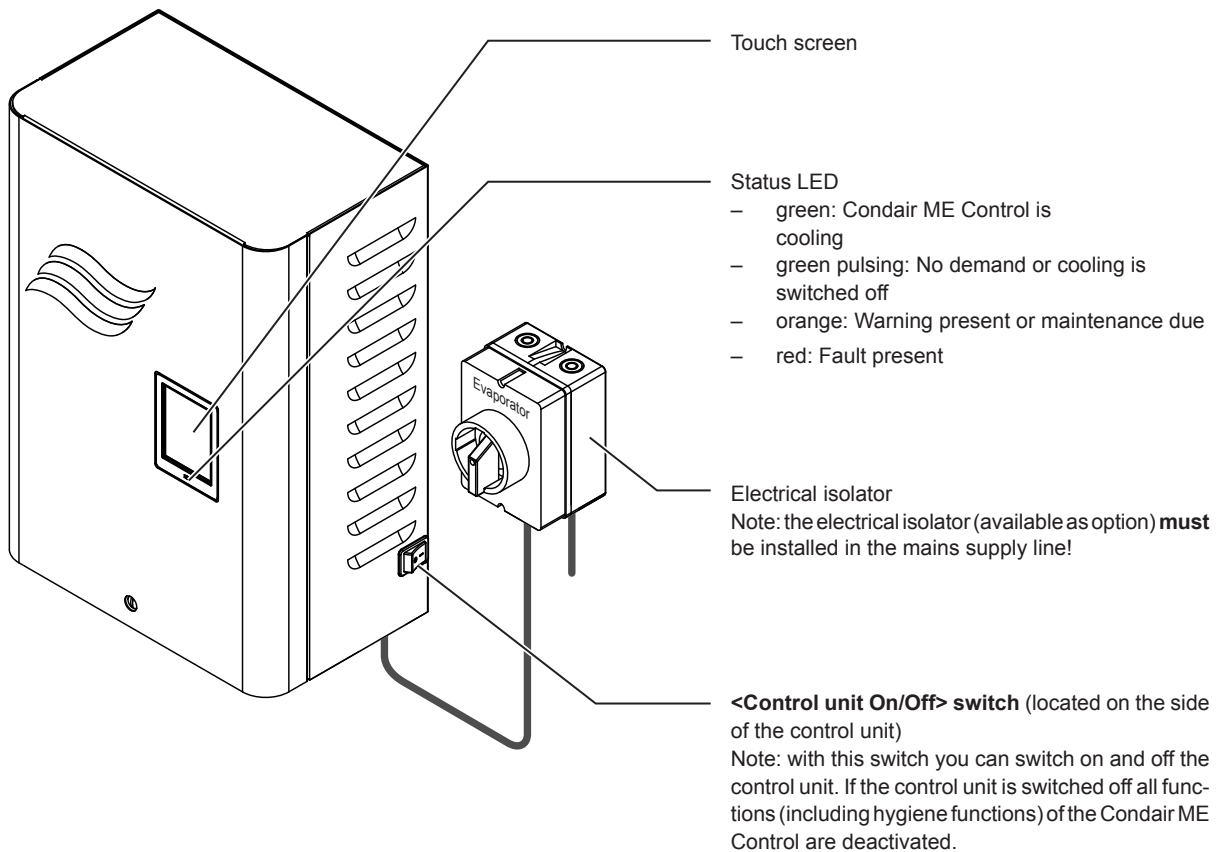

Fig. 9: Display and operating elements Condair ME Control



**DANGER!**  
**Risk of electric shock!**

There is still mains voltage inside the control unit even when you switch off the <Control unit On/Off> switch. Mains voltage provides a risk of electric shock, therefore the **electrical isolator must be switched off before opening the control unit**. Only qualified personnel should carry out work within the ME control unit.

## 4.4 Start up for normal operation

It is assumed that initial commissioning has been carried out properly by the service technician of your Condair representative.

**If the Condair ME Control has been out of operation for a prolonged period of time, the system must be examined for any damage or contamination. If doubts exist about the hygienic status of the system, the system must be cleaned and disinfected prior to the start up.**



**DANGER!**

Damaged systems or systems with damaged components or faulty installations may present danger to life or cause severe damage to material assets. Contaminated systems may present danger to health of persons.

**Therefore: Damaged systems and/or systems with damaged or faulty installation and/or contaminated systems must not be operated.**

Proceed as follows to prepare the Condair ME Control for operation:

1. Make sure the front panel of the control unit is mounted and fixed with the retaining screw.
  2. Ensure doors of AHU are closed, then switch on AHU (if switched off).
  3. Open shut-off valve in the water supply line.
  4. **Switch on the electrical isolator in the mains supply line** (mains supply to control unit).
  5. Switch **<Control unit On/Off>** switch on the side of the control unit to "On", and activate control unit via the external enable switch if necessary. Check for any fault or service message.
  6. If Condair ME Control has been disconnected from the mains for more than 48 hours the message "Out of Commissioning" appears. If this is the case proceed as follows:
    - Switch off control unit via the **<Control unit On/Off>** switch.
    - Examine system for any contamination. If doubts exist about the hygienic status of the system, the system must be cleaned and disinfected prior to the start up (including flushing of the water supply line).
    - Switch on control unit via the **<Control unit On/Off>** switch.
- Note: After switching on the control unit the "Out of Commissioning" message appears again, however the message is reset automatically after 1 minute and the Condair ME Control continues with normal operation.
7. If the display shows the message "Switched Off" enter the service menu and set the parameter "Operation" to "On".

The Condair ME Control is now in **normal operating mode** and the **standard operating display** is shown.

Note: further information on the operation of the Condair ME control software can be found in [chapter 5](#).

## 4.5 Notes on operation

### 4.5.1 Important notes on operation

- For hygiene reasons the supply valve opens in standby mode **every 12 hours for approximately 20 seconds** in order to flush water supply line.
- If no demand is present for more than 23 hours the tank will be drained.

### 4.5.2 Remote operating and fault indication (option)

The relays on the optional remote operating and fault indication board indicate the following operating system status:

Activated remote indication relay	When?
"Error"	An error is present, operation is stopped or further operation is possible for a limited period of time only.
"Service"	One of the maintenance counter has elapsed. The corresponding maintenance must be performed.
"Running"	Demand present/system is cooling
"Unit on"	The Condair ME Control is switched on and under voltage

### 4.5.3 Recommended regular checks during operation

During operation the Condair ME Control has to be checked periodically in accordance with the table below.

Operations Checks	Daily	Weekly	Monthly	Quarterly
Check cooling control for correct functioning	✓	✓	✓	✓
Check for any cooling concerns	✓	✓	✓	✓
Check any alarms on BMS	✓	✓	✓	✓
Visible check for: <ul style="list-style-type: none"> <li>– Units switched on with no fault lights</li> <li>– No water leakage (air on and air off side)</li> <li>– No water flow to drain (water may flow to drain during drain cycle and when unit loses cooling demand)</li> <li>– system components for correct fixing and any damage</li> <li>– electric installation for any damage.</li> </ul>	✓	✓	✓	✓
Check all UV bulbs are active when the water in the tank is at operating level (if optional UV bulb are installed)		✓	✓	✓
Check saturation of matrix media			✓	✓
Check condition of tanks and air on matrix is clean			✓	✓
Inspect and determine replacement frequency of sediment filter			✓	✓
Add disinfection chemical (according to tank volume)			✓	✓



Operations Checks	Daily	Weekly	Monthly	Quarterly
Check conductivity (reading below set point)			✓	✓
Check correct software settings				✓
Check condition of tank (clean as required)				✓
Check operating water level is correct (ensure unit is not in drain cycle)				✓

If the checks reveal any irregularities (e.g. leakage, error indication) or any damaged components take the Condair ME Control out of operation as described in [chapter 4.6](#). Then, have the malfunction eliminated or the damaged component replaced by a well trained specialist or a service technician from your Condair representative.

#### 4.5.4 Draining of the water tank

If draining of the water tank is required proceed as follows:

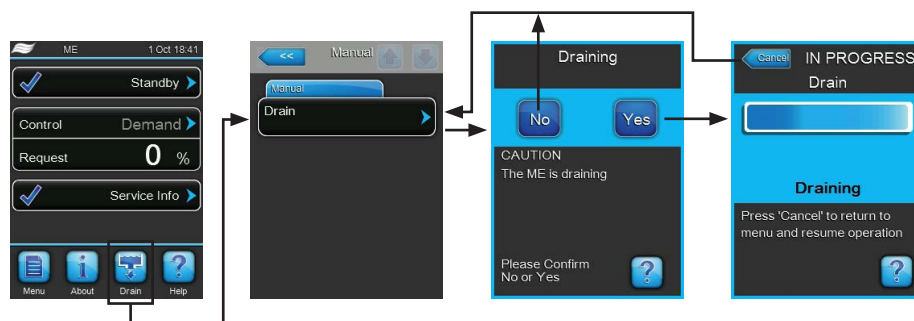

1. Close shut-off valve in the water supply line.
2. Press on the **<Drain>** button in the standard operating display.
3. Press on the menu item **<Drain>**. The drain confirmation dialogue appears.
4. Press on the **<Yes>** button to start draining of the water system. A possible running cooling process is interrupted. The progress bar in the display shows the current status of the drain process. After the tank is drained the control unit returns to the "Manual" submenu.  
Note: in order to stop the drain process press the **<Cancel>** button in the progress window. The drain process is stopped and the control unit returns to the "Manual" submenu.

## 4.5.5 Performing a matrix wash over

At initial commissioning when the "Matrix Wash Over" (W49) message appears or any time new fibre evaporative cassettes have been installed, a matrix wash over cycle has to be performed. If a matrix wash over cycle is required proceed as follows:

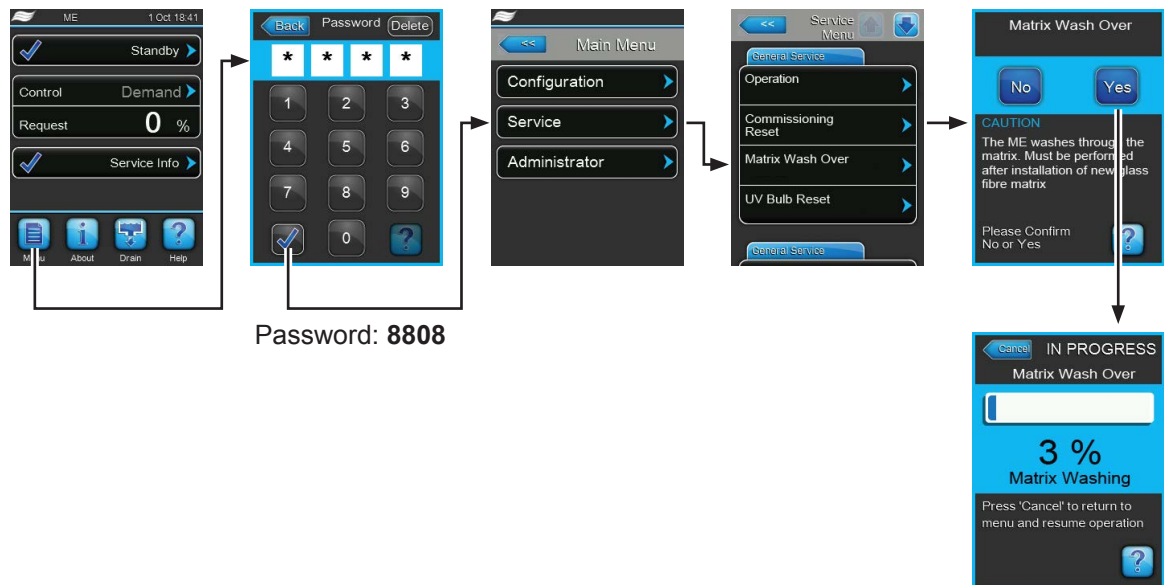

Condair ME Control is in normal operation mode.

1. Select the "Service" submenu (displays 1-3)
2. Select "Matrix Wash Over" function in the "Service" submenu. The matrix wash over confirmation dialogue appears.
3. Press on the **<Yes>** button to start the matrix wash over. A possible running cooling process is interrupted. The progress bar in the display shows the current status of the matrix wash over process. After the matrix wash over process is finished the control unit returns to the "Service" submenu.  
Note: in order to stop the matrix wash over process press the **<Cancel>** button in the progress window. The matrix wash over process is stopped and the control unit returns to the "Service" submenu.

## 4.6 Decommissioning the system

In order to decommission the Condair ME Control (e.g. to perform maintenance works, to eliminate a malfunction, etc.) perform the following steps:

1. If the system has to be switched off because of a malfunction, please note the Warning and Fault code(s) of the actual error message(s) shown in the fault history.
2. Close the shut-off valve in the water supply line.
3. Empty the water tank with the tank drain function (see [chapter 4.5.4](#)).
4. Switch off the **<Control unit On/Off>** switch on the control unit, and if necessary deactivate control unit via the external enable switch.
5. **Disconnect control unit from the mains:** switch off the electrical isolator in the mains supply to the control unit and secure switch in "Off" position against accidentally being switched on.
6. **Let the fan of the ventilation system run** until the evaporative module is dry.
7. If work has to be carried out on the evaporative module or the hydraulic module mounted inside the duct, switch off the AHU and secure the system against accidentally being switched on.

### Important Notes!

- If the Condair ME Control is in working order, then for hygiene reasons we recommend that the system should be left powered on, even if the Condair ME Control is not going to be used for a prolonged period of time. To prevent the Condair ME from cooling set the "Operation" function in the service menu to "Off". This keeps the hygiene functions (e.g. periodical flushing of water supply pipe) active and hence the build-up of bacteria is opposed.



### DANGER!

If the Condair ME system is isolated from the mains power for a prolonged period, water stagnation might occur in the supply pipework, and microbial contamination of the supply pipework and Condair ME system could result.

# 5 Operating the Condair ME control software

## 5.1 Standard operating display

After switching on the control unit and the automatic system test the control unit is in normal operating mode and the standard operating display is shown.

Note: the appearance of the standard operating display depends on the current operating status and the configuration of the control of the system and can deviate from the display shown below.

The standard operating display is structured as follows:

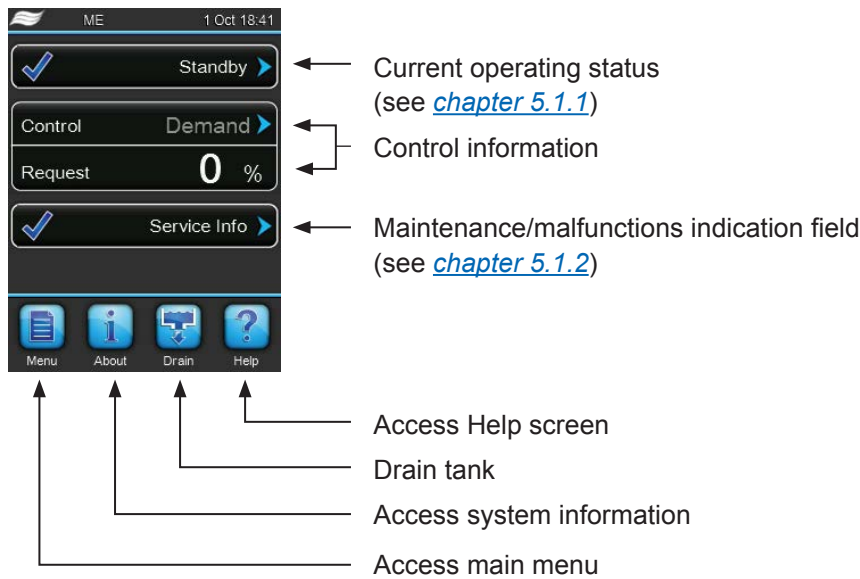

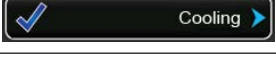

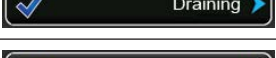
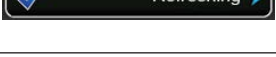

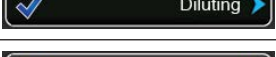
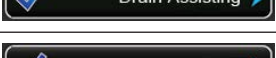
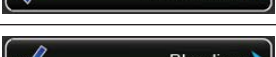
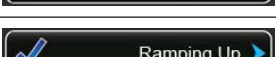







Fig. 10: Standard operating display









## 5.1.1 Operating status indication

The following operation status indications may appear during operation:













Operating status indication	Description
 Initializing	The control is initialising.
 Standby	No cooling demand for more than 60 minutes the cooling system is in standby mode.
 Cooling	The Condair ME is cooling.
 Holding	The Condair ME holds the current water level in the tank to be ready for operation.
 Draining	The Condair ME is draining the tank.
 Refreshing	If the water conductivity is not decreasing after a dilution, a water refresh cycle will be carried out (refill of the full tank). Note: This message appears only, if the system is equipped with the conductivity monitoring option.
 Filling	The Condair ME is filling the tank.
 Diluting	The water in the tank is being diluted to minimise limescale.
 Drain Assisting	After the demand has dropped to zero, the system drains a small amount of water to give space to the water running out of the matrix.
 Drain Check	The Condair ME Control is draining the tank and uses the first section of the drain procedure to check whether the drain valve is working properly.
 Bleeding	During operation the stage pumps are stopped periodically to bleed any air out of the pumps by the water flowing back from the distribution pipes.
 Ramping Up	The Condair ME is ramping up the water duty to the matrix.
 Switched Off	The operation is manually switched off. Note: the Condair ME Control can be switched on again by entering the service menu and setting the function "Operation" to "On".
 Remote Off	The Condair ME was stopped via the external enable switch.
 Purging	The inlet pipework is being purged.
 Diagnostic	The ME is in diagnostic mode, e.g. wash over activation through BMS.
 Stopped	The cooling system is stopped due to a malfunction which obviates further operation. Additionally "Warning" or "Fault" is displayed in the maintenance and malfunction field.

## 5.1.2 Maintenance and malfunction indications

The following maintenance and malfunction indications may appear during operation:

Operating status indication	Description
 Service Info ▶	No malfunction present. By pressing on the indication field the service menu can be accessed.
 ME Service ▶	The system service is due. If the system service is not performed within 30 days a fault message is triggered. The system remains operable.
 Refill Liquid ▶	The external liquid container of the dosing pump is empty.
 Replace UV Bulb ▶	The lifetime of the UV bulb has expired and must be replaced.
 Matrix Wash Over ▶	As new matrix has been installed, a matrix wash over cycle needs to be carried out.
 Out of Commissioning ▶	This message appears after switching on, if the control unit has been isolated from the mains supply for more than 48 hours. The Condair ME Control is blocked for 5 minutes. Before operation the water supply line to the hydraulic module must be flushed. The commissioning warning is reset automatically after 5 minutes or you can reset the warning in the "Service" submenu (see <a href="#">chapter 5.5.2</a> ).
 Warning ▶	A malfunction with status "Warning" is active. Additionally the yellow LED lights. Depending on the malfunction the cooling system is either be stopped or stays operable for a certain period of time.
 Fault ▶	A malfunction with status "Fault" is active. Additionally the red LED lights. Depending on the malfunction the cooling system is either be stopped or stays operable for a certain period of time.

## 5.2 Navigating/operating the Condair ME control software

Navigation element	Action
	Accessing main menu
	Accessing system information
	Performing a tank drain
	Accessing Help screen
	If you press on a field with a blue arrow symbol a new screen with additional information or settings appears.
	This symbol on the left side of the operating status field and of the maintenance/malfunctions indication field indicates, that the system is working ok.
	This symbol on the left side of the maintenance/malfunctions indication field indicates, that a Warning is present. Press on the field to get further information.
	This symbol on the left side of the operating status field and of the maintenance/malfunctions indication field indicates, that a Fault is present (additionally the LED lights red). Press on the field to get further information.
	Jumps back to previous screen (cancel and back)
	Scroll up/down
	Increase/decrease value
	Delete shown value
	Confirm set value or selected option

## 5.3 Information functions

### 5.3.1 Accessing support information



In the standard operating display press the **<Help>** button.  
The screen with the support information appears.

### 5.3.2 Accessing system information

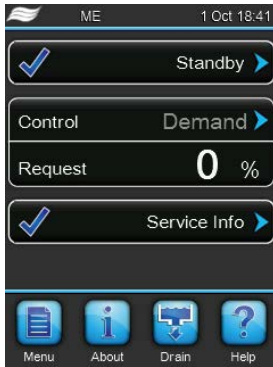

In the standard operating display press the **<About>** button.

The system information screen appears. Use the arrow buttons to scroll up and down within the system information screen.

#### Operating Tab



- **Actual Stage:** Actual number of currently operating stages of the system.
- **Max Stage:** Number of maximum stages set to operate.
- **Max. Capacity:** Maximum evaporating capacity in kg/h or lb/hr.



## Service Tab



- **Hours of Operation:** Operating hours since initial commissioning of the system.
- **Next ME Service:** Remaining time until next maintenance of the system must be performed.
- **Next UV Bulb:** Remaining time until the UV bulb of the optional UV device must be replaced.

## Features Tab

The content of the "Features" information section depends on the set dilution mode.



Dilution mode set to **"Fill Cycle"**:

- **Dilution Fill cycle:** Actual set fill cycles for periodical tank draining depending on the fill cycles.
- **Drain Interval:** Actual set tank drain interval time.
- **Incoming Air Temperature:** Actual temperature of the air before the evaporative cassettes.  
Note: This information field appears only if optional freeze protection sensor is installed and the optional freeze protection function is activated in the engineering menu.

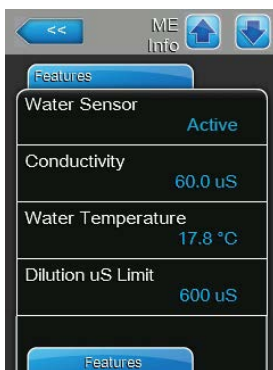

Dilution mode set to **"Condu Limit"**:

- **Water Sensor:** Indicates whether the water sensor is currently "Active" (monitoring the water conductivity & temperature) or "Inactive" (water level is too low to monitor).
- **Conductivity:** Actual conductivity of the water in the tank in  $\mu\text{S}$  ( $\mu\text{S}/\text{cm}$ ).
- **Water Temperature:** Actual temperature of the water in the tank in  $^{\circ}\text{C}$  or  $^{\circ}\text{F}$ .
- **Dilution  $\mu\text{S}$  Limit:** Actual set conductivity limit value if exceeded a dilution cycle is triggered.
- **Drain Interval:** Actual set tank drain interval time.
- **Incoming Air Temperature:** Actual temperature of the air before the evaporative cassettes.  
Note: This information field appears only if optional freeze protection sensor is installed and the optional freeze protection function is activated in the engineering menu.



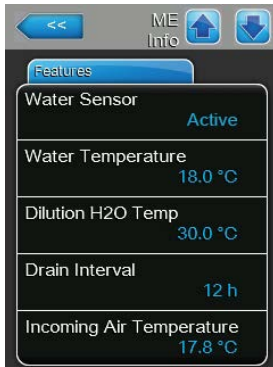

Dilution mode set to "**Dilution H2O Temp**":

- **Water Sensor:** Indicates whether the water sensor is currently "Active" (monitoring the water conductivity & temperature) or "Inactive" (water level is too low to monitor).
- **Water Temperature:** Actual temperature of the water in the tank in °C or °F.
- **Dilution H2O Temp:** Actual set water temperature limit value in °C or °F if exceeded a dilution cycle is triggered.
- **Drain Interval:** Actual set tank drain interval time.
- **Incoming Air Temperature:** Actual temperature of the air before the evaporative cassettes.

Note: This information field appears only if optional freeze protection sensor is installed and the optional freeze protection function is activated in the engineering menu.



Dilution mode set to "**Dilution Interval**":

- **Dilution Interval:** Actual set dilution interval time, for periodic dilution of the water in the tank.
- **Drain Interval:** Actual set tank drain interval time.
- **Incoming Air Temperature:** Actual temperature of the air before the evaporative cassettes.

Note: This information field appears only if optional freeze protection sensor is installed and the optional freeze protection function is activated in the engineering menu.

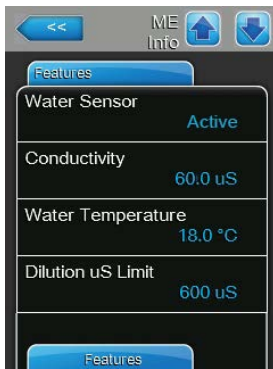

Dilution mode set to "**Condu & Temp**":

- **Water Sensor:** Indicates whether the water sensor is currently "Active" (monitoring the water conductivity & temperature) or "Inactive" (water level is too low to monitor).
- **Conductivity:** Actual conductivity of the water in the tank in  $\mu\text{S}$  ( $\mu\text{S}/\text{cm}$ ).
- **Water Temperature:** Actual temperature of the water in the tank in °C or °F.
- **Dilution  $\mu\text{S}$  Limit:** Actual set conductivity limit value if exceeded a dilution cycle is triggered.
- **Dilution H2O Temp:** Actual set water temperature limit value in °C or °F if exceeded a dilution cycle is triggered.



- **Drain Interval:** Actual set tank drain interval time.
- **Incoming Air Temperature:** Actual temperature of the air before the evaporative cassettes.

Note: This information field appears only if the optional freeze protection sensor is installed and the optional freeze protection function is activated in the engineering menu.

## Network Tab

The information shown in the "Network" tab varies depending on whether a BMS (building management system) communication protocol is enabled, and which communication protocol is selected. If no BMS protocol is enabled, then only "Online Status" and "IP Address" are shown.

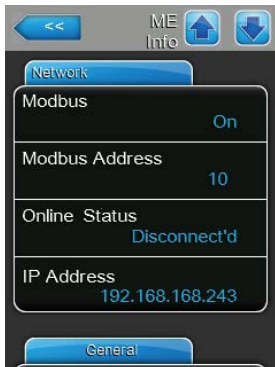

### Modbus Network

- **Modbus**: shows the current status of the Modbus communications protocol. Note: This menu item appears only if the Modbus communication protocol is enabled. Further information on Modbus communication can be found in the separate Modbus addendum manual. This manual can be requested from your Condair representative.
- **Modbus Address**: shows the Modbus address of the Condair ME Control. Note: This menu item appears only if the Modbus communication protocol is enabled, and the BACnet communication protocol is disabled.
- **Online Status**: shows the connection status of the Condair ME Control to Condair Online ("Connected" or "Disconnect'd").
- **IP Address**: shows the IP address of the Condair ME Control.



### BACnet MSTP Network / BACnet IP Network

- **BACnet**: shows the currently selected BACnet onboard communication protocol ("MSTP" or "BACnet/IP"). Note: This field appears only if the BACnet communication protocol is enabled. Further information on BACnet IP and BACnet MSTP communication can be found in the separate BACnet addendum manual. This manual can be requested from your Condair representative.

#### BACnet MSTP Network

- **BACnet MSTP MAC**: shows the actual BACnet MSTP MAC address for the Condair ME Control. Note: This field appears only if "BACnet MSTP" is enabled.

#### BACnet IP Network

- **Node ID**: shows the actual BACnet node ID for the Condair ME Control. Note: This field appears only if "BACnet IP" is enabled.
- **Online Status**: shows the connection status of the Condair ME Control to Condair Online ("Connected" or "Disconnect'd").
- **IP Address**: shows the IP address of the Condair ME Control.



## General Tab

Within the "General" tab various unit data is shown. Additionally you can access a graphical display of the Condair ME Control performance data, and you can save the performance data to a USB memory stick as a .csv file.



- **Humidifier Model:** Designation of the unit model.
- **Software Version:** Actual version of the control software.
- **Driver Board A:** Actual software version of the driver board.
- **Driver Condu.:** Actual software version of the conductivity monitoring board.



- **Serial Number:** Serial number of the Condair ME Control.
- **Graph:** With this function you can access the graphical display of the performance data for the Condair ME Control.
- **Export Trend Data:** With this function you can save the performance data to a USB memory stick (FAT32 formatted) as a .csv file.  
Note: before carrying out this function, a FAT32 formatted USB memory stick must be connected to the USB port on the control board.

## 5.4 Configuration

### 5.4.1 Accessing the "Configuration" submenu

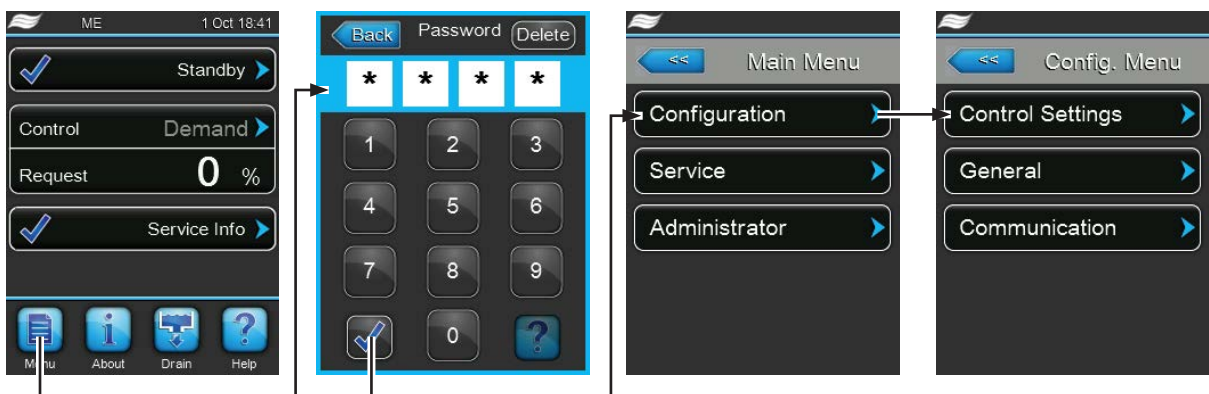

Password: 8808

## 5.4.2 Control settings – "Control Settings" submenu

In the "Control Settings" submenu you determine the control settings for the Condair ME Control. The control settings available depend on the selected signal source and the control mode.

### Basic Tab

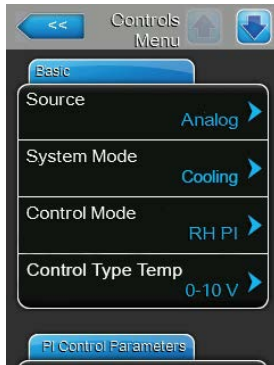

- **Source:** with this setting you determine whether the control signal comes from an analogue source (signal of a temperature sensor or demand signal from an external temperature controller) or via Modbus or BACnet.  
Factory setting: **Analog**  
Options: **Analog**  
**Modbus**  
**BACnet**
- **System Mode:** this setting must be set to "Cooling" and may not be changed.  
Factory setting: **Cooling**
- **Control Mode:** with this setting you determine the type of controller used with the Condair ME Control.  
Factory setting: **On/Off**  
Options: **On/Off** (external On/Off thermostat)  
**Demand** (external continuous controller)  
**RH P** (internal P controller)  
**RH PI** (internal PI controller)
- **Signal Type Temp:** with this setting you determine the control signal type for temperature control  
Note: this setting appears only if signal source is set to "Analog" and "Control Mode" is set to "Demand", "RH P" or "RH PI".  
Factory setting: **0-10 V**  
Options: **0-5V, 1-5V, 0-10V, 2-10V, 0-20V, 0-16V, 3.2-16V, 0-20mA, 4-20mA**

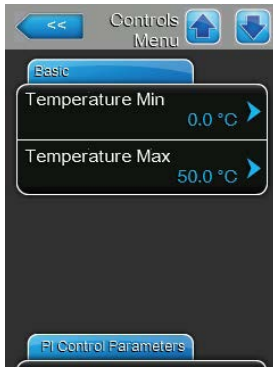

- **Temperature Min:** with this setting you determine the minimum temperature of the measuring range of the temperature sensor used.  
 Note: this setting appears only if "System Mode" is set to "Cooling" and "Control Mode" is set to "RH P" or "RH PI".  
 Factory setting: **0.0 °C (32 °F)**  
 Setting range: **-50.0 ... +100 °C (-58 ... 212 °F)**
- **Temperature Max:** with this setting you determine the maximum temperature of the measuring range of the temperature sensor used.  
 Note: this setting appears only if "System Mode" is set to "Cooling" and "Control Mode" is set to "RH P" or "RH PI".  
 Factory setting: **50.0 °C (122 °F)**  
 Setting range: **-50.0 ... +100 °C (-58 ... 212 °F)**

### PI Control Parameters Tab



- **Setpoint Channel 2:** with this setting you set the temperature setpoint of channel 2 ("Cooling") in °C or °F.  
 Note: this setting appears only if the "Control Mode" is set to "RH P" or "RH PI".  
 Factory setting: **20 °C (68 °F)**  
 Setting range: **5 ... 40 °C (41... 104 °F)**
- **Band Channel 2:** with this setting you set the proportional range of channel 2 ("Cooling") in °C or °F.  
 Note: this setting appears only if the "Control Mode" is set to "RH P" or "RH PI".  
 Factory setting: **10 °C (50 °F)**  
 Setting range: **1.0 ... 50.0 °C (34 ... 122 °F)**
- **ITime Channel 2:** with this setting you set the integral time of channel 2 ("Cooling") in minutes.  
 Note: this setting appears only if the "Control Mode" is set to "RH PI".  
 Factory setting: **5 minutes**  
 Setting range: **1 ... 60 minutes**

## Stage switching Tab

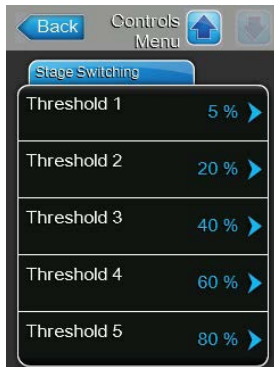

- **Threshold 1:** With this setting you determine the set point at which the pump of stage 1 will switch on or off in % of the demand signal.  
Factory setting: **5%**  
Setting range: **2 ... 99 %**
- **Threshold 2:** With this setting you determine the set point at which the pump of stage 2 will switch on or off in % of the demand signal.  
Factory setting: **Varies with number of stages**  
Setting range: **2 ... 99 %**
- **Threshold 3:** With this setting you determine the set point at which the pump of stage 3 will switch on or off in % of the demand signal.  
Factory setting: **Varies with number of stages**  
Setting range: **2 ... 99 %**
- **Threshold 4:** With this setting you determine the set point at which the pump of stage 4 will switch on or off in % of the demand signal.  
Factory setting: **Varies with number of stages**  
Setting range: **2 ... 99 %**
- **Threshold 5:** With this setting you determine the set point at which the pump of stage 5 will switch on or off in % of the demand signal.  
Factory setting: **Varies with number of stages**  
Setting range: **2 ... 99 %**



### 5.4.3 Basic settings – "General" submenu

In the "General" submenu you determine the basic settings for operating the Condair ME Control control unit.

#### Basic Tab



- **Date:** With this setting you determine the current date in the set format ("MM/DD/YYYY" or "DD/MM/YYYY").  
Factory setting: **00/00/0000**
- **Time:** With this setting you set the current hour of the day in the set time format ("12H" or "24H").  
Factory setting: **12:00**
- **Language:** With this setting you determine the dialogue language.  
Factory setting: **depending on the country**  
Options: **different dialogue languages**
- **Units:** With this setting you determine the desired unit system.  
Factory setting: **Metric**  
Options: **Metric or Imperial**

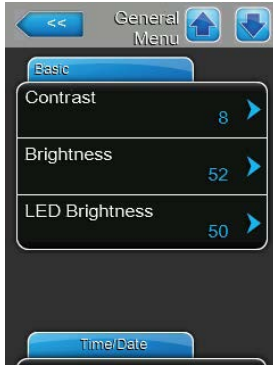

- **Contrast:** With this setting you determine the desired value for the display contrast.  
Factory setting: **8**  
Options: **1 (weak contrast) ... 31 (strong contrast)**
- **Brightness:** With this setting you determine the desired value for the display brightness.  
Factory setting: **52**  
Options: **1 (dark) ... 100 (white)**
- **LED Brightness:** with this setting you determine the desired value for the brightness of the operation indication LED.  
Factory setting: **52**  
Options: **1 (weak) ... 100 (bright)**

#### Time/Date Tab



- **Date Format:** With this setting you determine the desired date format.  
Factory setting: **DD/MM/YYYY**  
Options: **DD/MM/YYYY or MM/DD/YYYY**
- **Clock Format:** With this setting you determine the desired time format.  
Factory setting: **24H**  
Options: **24H (24 hours, display 13:35) or 12H (12 hours, display: 01:35 PM)**



## 5.4.4 Communication settings – "Communication" submenu

In the "Communication" submenu you determine the parameters for the communication.

### Network Parameters Tab

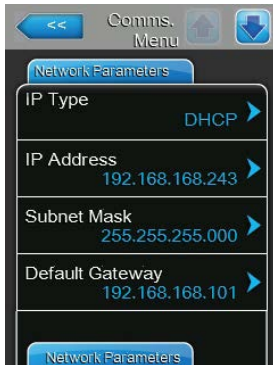

The following network settings are used for the communication via the integrated interface of the integrated controller of the Condair ME Control.

- **IP Type:** with this setting you determine whether you want to assign the IP Address, the Subnet Mask, the Standard Gateway as well as the Primary and Secondary DNS address as fixed values or whether these should be dynamically assigned via a DHCP server.

Note: after 5 unsuccessful attempts at obtaining an address with DHCP the system will revert to fixed assignment

Factory setting: **DHCP**

Options: **DHCP** (dynamic assignment)

**Fixed** (fixed assignment)

- **IP Address:** with this setting you manually enter the IP Address of the Condair ME Control.  
Note: This IP Address is used if "IP Type" is set (or reverts) to "Fixed".
- **Subnet Mask:** with this setting you determine the Subnet Mask of the IP network.  
Note: This Subnet Mask is used if "IP Type" is set (or reverts) to "Fixed".
- **Default Gateway:** with this setting you determine the IP Address of the Default Gateway.  
Note: This IP Address for the Default Gateway is used if "IP Type" is set (or reverts) to "Fixed".
- **Primary DNS:** with this setting you determine the IP Address of the Primary Domain Name Server (DNS).  
Note: This IP Address for the Primary Domain Name Server is used if "IP Type" is set (or reverts) to "Fixed".
- **Secondary DNS:** with this setting you determine the IP Address of the Secondary Domain Name Server (DNS).  
Note: This IP Address for the Secondary Domain Name Server is used if "IP Type" is set (or reverts) to "Fixed".
- **MAC Address:** with this setting you determine the MAC Address (Media Access Control Address) of the Condair ME Control.
- **Host Name:** with this setting you determine the Host Name of the Condair ME Control.

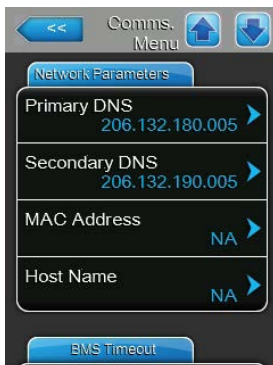

### BMS Timeout Tab

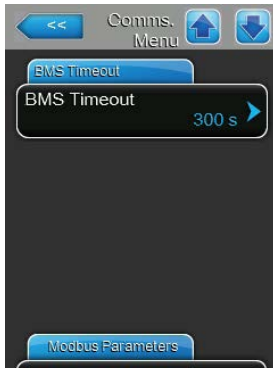

- **BMS Timeout:** with this setting you determine the maximum time the Condair ME Control will wait with no communication from the BMS network before a BMS timeout warning is generated. Exceeding the timeout also stops the Condair ME Control operation if the signal source of the surface evaporator is set to a BMS input.

Factory setting: **300 s**

Setting range: **1 ... 300 s**

### Modbus Parameters Tab

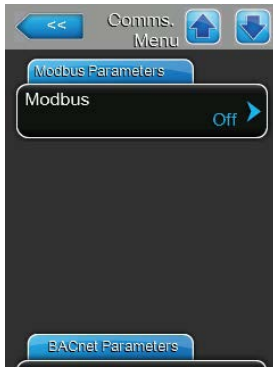

- **Modbus:** with this setting you can activate "**Modbus/RTU**" or "**Modbus/TCP**" communication via a Modbus network or deactivate ("Off") Modbus communication.

Factory setting: **Modbus/RTU**

Options: **Off, Modbus/RTU or Modbus/TCP**

**Important:** regarding the setting of the individual Modbus parameters as well as the wiring of the Condair ME Control for the Modbus communication, please observe the instructions in the separate Modbus addendum manual. This manual can be requested from your Condair representative.

### BACnet Parameters Tab



- **BACnet:** with this setting you can activate ("MSTP" or "BACnet/IP") or deactivate ("Off") the communication via the integrated BACnet interfaces.

Factory setting: **Off**

Options: **Off** (BACnet interface deactivated)

**MSTP** (BACnet MSTP via RS 485 interface)

**BACnet/IP** (BACnet/IP via RJ45 interface)

**Important:** regarding the setting of the individual BACnet parameters as well as the wiring of the Condair ME Control for the BACnet Ip or BACnet MS/TP communication, please observe the instructions in the separate BACnet addendum manual. This manual can be requested from your Condair representative.

## Remote Fault Board Tab



- **Indication:** With this setting you determine whether only maintenance messages ("Service") or all Warning messages ("Warning") are outputted via the service relay of the optional remote operating and fault indication board.  
Factory setting: **Service**  
Options: **Service or Warning**
- **Safety Chain Indication:** With this setting you determine whether a Fault ("On") or a Warning ("Off") is triggered when the external safety chain is open.  
Factory setting: **Off**  
Options: **Off or On**

## 5.5 Service functions

### 5.5.1 Accessing the "Service" submenu

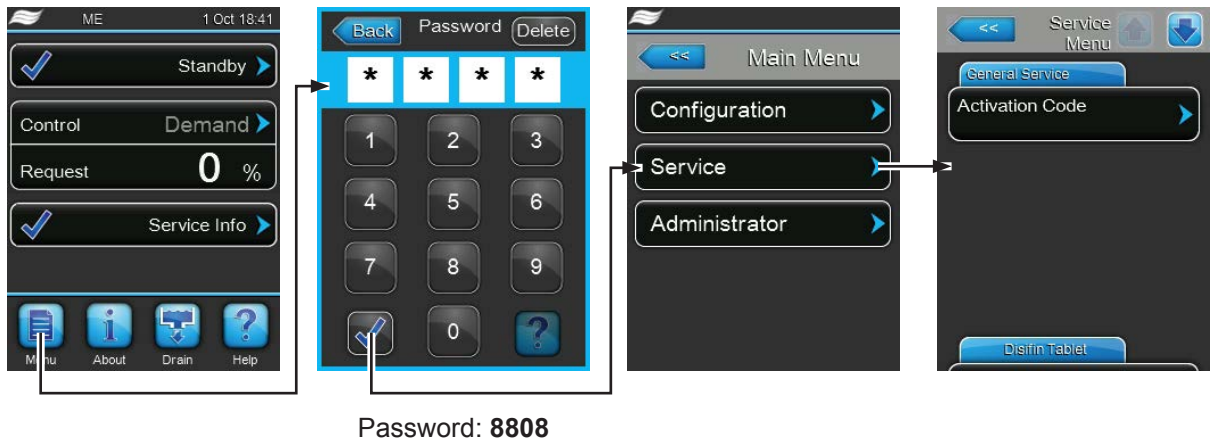

### 5.5.2 Performing maintenance functions – "Service" submenu

In the "Service" submenu you can enter the activation code, accessing and resetting the fault and maintenance history and performing different input and output diagnostic functions.

#### General Service Tab



- **Operation:** with this function you can turn on or off the Condair ME Control cooling operation. The System remains energized and all hygiene functions will still be carried out.  
Factory Setting: **On**  
Options: **On or Off**
- **Commissioning Reset:** with this function you can reset the "Out of Commissioning" message, which appears if the control unit has been disconnected from the mains for more than 48 hours. After pressing on the "Commissioning Reset" button a confirmation window appears where the resetting must be confirmed.  
Note: after resetting the control unit must be connected to the mains for at least 15 minutes, otherwise the "Out of Commissioning" message appears on the next startup again.
- **Matrix Wash Over:** with this function you can wash over the evaporative cassette matrix. After pressing on the "Matrix Wash Over" button the wash over cycle is automatically started.  
Note: Use this function to wash over newly installed glass fibre evaporative cassettes to remove any dust and glue left after the manufacture of evaporative cassette material. The wash over is mandatory for newly installed systems with glass fibre type evaporative cassettes.
- **UV Bulb Reset:** with this function you can reset the UV Bulb replacement message after having replaced the UV bulb. This menu item appears only, if this option is installed and activated..  
Note: Resetting the UV Bulb replacement message without having replaced the UV Bulb may lead to contamination of the system.

- **ME Service Reset:** with this function you can reset the "System Service" message after having performed a system service.  
Note: Resetting the "System Service" message without having performed a system service may lead to contamination of the system.

### Disinfection Tab



- **Disinfection Demand:** With this function you can set the humidity demand during the disinfection process. During disinfection, the demand is set to the specified value.  
Factory Setting: **100 %**  
Setting Range: **100 % (100 % demand)**  
**0 % (No demand)**  
**Demand Signal** (Demand corresponds to the current demand signal)
- **Disinfection Duration:** With this function you can define the duration of the disinfection process.  
Factory Setting: **60 Minutes**  
Setting Range: **1-900 Minutes**
- **Start Disinfection:** With this function you can start the disinfection process with current settings.

### Fault/Service History Tab



Note: the fault and maintenance events stored can be correctly analysed only if the date and the time of day are correctly set.

- **Fault History:** with this function you can access the fault history list where the last 40 fault events are stored. After pressing on the "Fault History" button the fault history list appears.
- **Service History:** with this function you can access the service history list where the last 40 service events are stored. After pressing on the "Service History" button the service history list appears.
- **Export History:** with the function "Export History" you can export the fault and service history list to a FAT32 formatted USB memory stick via the USB port on the control board (see [chapter 7.3](#))

### Diagnostics Tab



- **Input Diagnostics:** with this function you can access the "Input Diagnostics" submenu where you can view different current input values the control system is receiving. Detailed information can be found in [chapter 5.5.2.1](#).
- **Relay Diagnostics:** with the "Relay Diagnostics" function you can access the "Relay Diagnostics" submenu where you can activate or deactivate the relays of the optional remote operating and fault indication board. Detailed information on the individual relay diagnostic functions can be found in [chapter 5.5.2.2](#).

Note: By accessing the "Relay Diagnostics" submenu the cooling system is automatically switched to standby operation.

### 5.5.2.1 Input diagnostic functions – "Input Diagnostics" submenu

The following input values can be viewed after accessing the "Input Diagnostics" submenu.

Note: the input values can be accessed and viewed too, via the "Service Info" selection field in the standard operating display.

#### Control Tab



- **Humidity control:** Actual demand signal in %.
- **Temperature Control:** Temperature of area being controlled.
- **Safety Chain:** Actual status of the safety chain ("Open"= Safety chain open, "Closed"= Safety chain closed).
- **Enable:** Actual status of the external enable switch, if present ("Off"= switch open, "On"= switch closed).

#### ME Conditions Tab

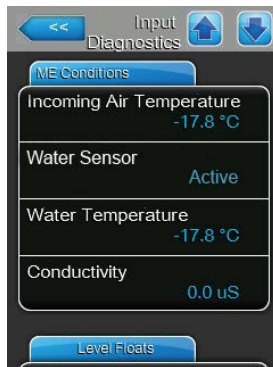

The ME Conditions section shows operating parameters of options, if installed:

- **Incoming Air Temperature:** Actual air temperature of the incoming air in °C or °F if optional duct temperature sensor is installed.
- **Water Sensor:** Indicates whether the water sensor is currently "Active" (monitoring the water conductivity & temperature) or "Inactive" (water level is too low to monitor).
- **Water Temperature:** Actual temperature of the water in the tank in °C or °F if optional temperature sensor is installed.
- **Conductivity:** Actual conductivity of the water in the tank in  $\mu\text{S}/\text{cm}$  if optional conductivity sensor is installed.

#### Level Floats Tab

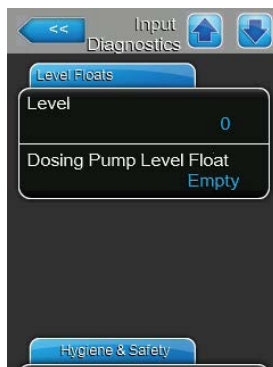

- **Level:** Actual level (1 to 6) in the tank of the evaporative module captured by the level sensor.
- **Dosing Pump Level Float:** Actual level ("Empty"= Tank is empty or "OK"=Level in the tank is OK) in the liquid tank of the optional system for enhancing polyester media water absorption.



## Hygiene & Safety Tab

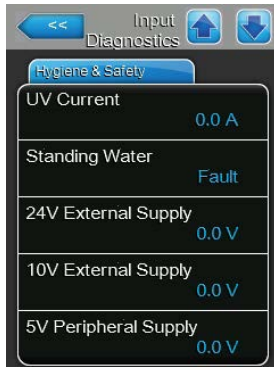

- **UV Current:** Actual current draw of the submerged UV lamps, if the submerged UV option is installed.
- **Standing Water:** Actual status of the leakage monitoring option (fault=leakage present, OK= no leakage).
- **24V External Supply:** Actual voltage of the external 24 V supply for devices outside the control unit, such as thermostat, safety chain, etc.
- **10V External Supply:** Actual voltage of the external 10 V supply for devices outside the control unit, such as temperature sensors, thermostats, etc.
- **5V Peripheral Supply:** Actual voltage of the peripheral 5 V supply for options fitted inside the control unit.

## Valve Feedback Tab

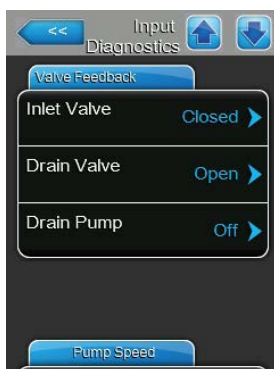

- **Inlet Valve:** Actual status of inlet solenoid valve ("Open" or "Closed").
- **Drain Valve:** Actual status of gravity drain solenoid valve ("Open" or "Closed").
- **Drain Pump:** Actual status of drain pump ("On" or "Off").

## Pump Speed Tab

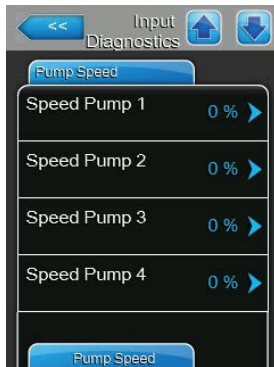

- **Speed Pump 1:** Actual speed of stage pump 1 in % of the maximum speed.
- **Speed Pump 2:** Actual speed of stage pump 2 in % of the maximum speed.
- **Speed Pump 3:** Actual speed of stage pump 3 in % of the maximum speed.
- **Speed Pump 4:** Actual speed of stage pump 4 in % of the maximum speed.

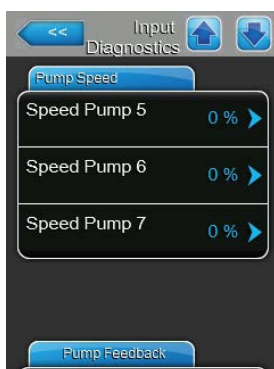

- **Speed Pump 5:** Actual speed of stage pump 5 in % of the maximum speed.
- **Speed Pump 6:** No function.
- **Speed Pump 7:** No function.

## Pump Feedback Tab

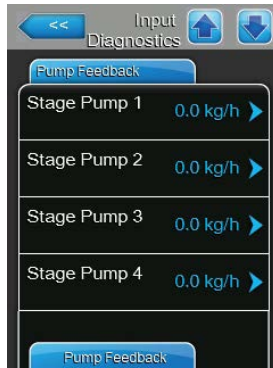

- **Stage Pump 1:** Actual flow rate of stage pump 1 in kg/h or lb/hr.
- **Stage Pump 2:** Actual flow rate of stage pump 2 in kg/h or lb/hr.
- **Stage Pump 3:** Actual flow rate of stage pump 3 in kg/h or lb/hr.
- **Stage Pump 4:** Actual flow rate of stage pump 4 in kg/h or lb/hr.

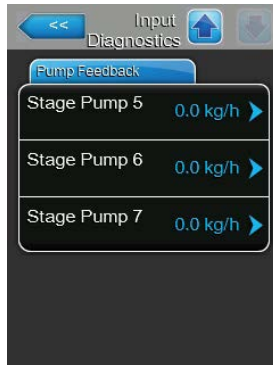

- **Stage Pump 5:** Actual flow rate of stage pump 5 in kg/h or lb/hr.
- **Stage Pump 6:** No function.
- **Stage Pump 7:** No function.

### 5.5.2.2 Relay diagnostic functions – "Relay Diagnostics" submenu

The following diagnostic functions are available after accessing the "Relay Diagnostics" submenu.

#### General Tab

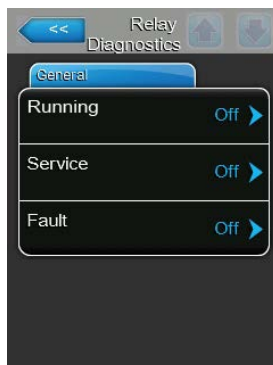

- **Running:** with this function you can activate ("On") and deactivate ("Off") the relay "Running" on the remote operating and fault indication board, which indicates that the unit is cooling.
- **Service:** with this function you can activate ("On") and deactivate ("Off") the relay "Service" on the remote operating and fault indication board, which indicates that a service is due.
- **Fault:** with this function you can activate ("On") and deactivate ("Off") the relay "Fault" on the remote operating and fault indication board, which indicates that a fault is present.



## 5.6 Administration settings

### 5.6.1 Accessing "Administrator" submenu

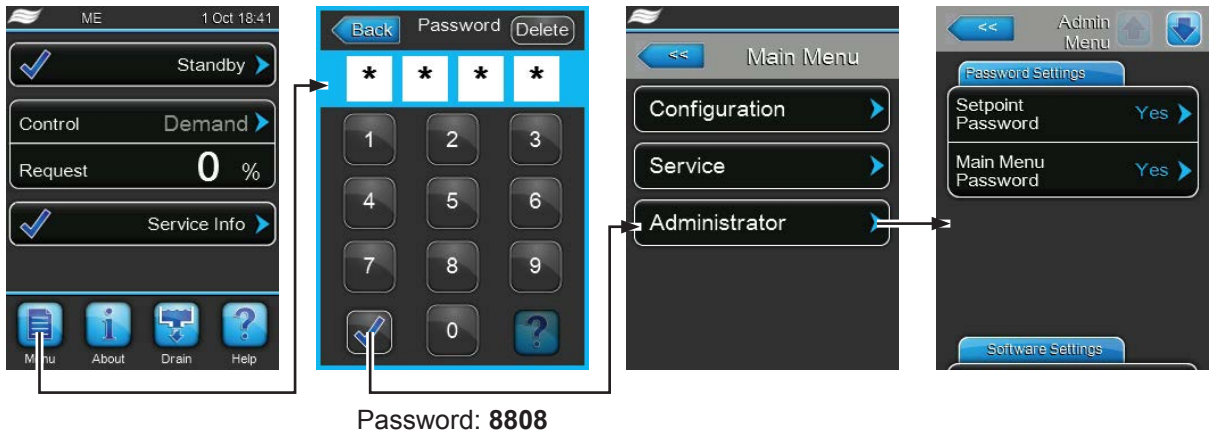

### 5.6.2 Administration settings – "Administrator" submenu

In the "Administrator" submenu you can:

- activate or deactivate password protection for main menu and setpoint adjustment access.
- perform software updates via a USB memory medium connected to the USB port

#### Password Settings Tab



- **Setpoint Password:** with the function "Setpoint Password" you can protect the setpoint input screen with the user password "8808" against unauthorised access ("Yes") or not ("No").
- **Main Menu Password:** with the function "Main Menu Password" you can protect the access to the main menu with the user password "8808" against unauthorised access ("Yes") or not ("No").

## Software Update Tab



- **Software Update:** with the function "Software Update" you can update the control software of the integrated controller (see [chapter 6.10](#)).
- **Driver Board A Update:** with the function "Driver Board A Update" you can update the driver board software (see [chapter 6.10](#)).
- **Driver Condu. Update:** with the function "Driver Condu. Update" you can update the conductivity board software (see [chapter 6.10](#)).

## Software Settings Tab

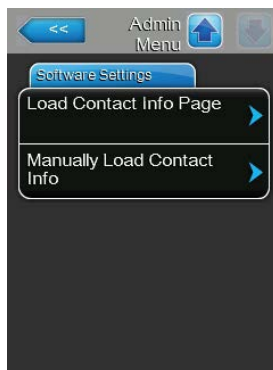

- **Load Contact Info Page:** this function allows you to upload pre-made contact information data (which are displayed when pressing the <Help> button) from a USB memory stick connected to the USB port on the control board.
- **Manually Load Contact Info:** this function allows you to manually change/enter contact information data (which are displayed when pressing the <Help> button).

# 6 Maintenance

## 6.1 Important notes on maintenance

### Qualification of personnel

All maintenance work must be carried out only by **well qualified and trained personnel authorised by the owner**. It is the owner's responsibility to verify proper qualification of the personnel.

### General notes

The instructions and details for maintenance work must be followed and upheld. Only carry out the maintenance work described in this documentation.

The Condair ME Control must be maintained in the prescribed intervals, the cleaning work must be carried out correctly.

For safety and warranty reasons, only use original spare parts from your Condair representative to replace defective parts or parts which have elapsed their lifetime.

### Safety and hygiene

Some maintenance work requires removal of the unit cover. Please note the following:

 **DANGER!**  
Danger of electric hazard!

**Before carrying out any maintenance work take the Condair ME Control out of operation as described in [chapter 4.6](#) and secure the system against inadvertent power-up.** In addition take AHU out of operation as described in the operation instructions of the AHU and secure the AHU against inadvertent power-up.

 **CAUTION!**

The electronic components inside the control unit are very sensitive to electrostatic discharge.

**Prevention:** Before carrying out any maintenance work to the electrical or electronic equipment of the control unit, appropriate measures must be taken to protect the respective components against damage caused by electrostatic discharge (ESD protection).

 **DANGER!**  
Health risk by inadequate maintenance!

**Inadequately operated and/or poorly maintained surface evaporators may endanger health. When inadequately operated and/or poorly maintained, micro-organisms may grow in the water system and in the area of the evaporative module and may affect the air in the AHU/air duct.**

**Prevention:** the Surface evaporator Condair ME must be correctly operated as described in [chapter 4](#), and must be correctly maintained and cleaned in the prescribed intervals as described in [chapter 6](#).



## WARNING!

In the event of water carry-over from the evaporative cassettes or due to a water leakage, surfaces near the ME evaporative module may have become wet. This could result in a slipping hazard or an increased risk when handling components.

**Prevention:** before carrying out any work on the evaporative module dry all wet surfaces in the AHU/duct.

---

## 6.2 Maintenance intervals

In order to maintain operational safety and hygienic demands the Condair ME Control must be serviced at regular intervals. The time interval for the system service is to be adapted to the operating conditions. The hygiene status depends mainly on the quality of the supply water but also on the adherence to the exchange intervals of the upstream air filter, the air velocity and the micro-biological and chemical composition of the supply air. Therefore the service intervals must be determined for each system separately.

The interval time for a system service is to be determined at commissioning. The default is **1000 hours of operation**.

Depending on the encountered hygiene status when performing a system service the interval time must be decreased or increased.

**In any case the Condair ME Control system should receive a complete service at least once annually.**

Note: We recommend to perform a minor service between two system services.

The interval time for system service can be programmed on the control unit. To determine the interval time for a system service the above described procedure can be used. As soon as the maintenance time has elapsed, a maintenance message is displayed to draw your attention to the pending service.

## 6.3 Maintenance guide

Please note that the information given in the table below is only to act as a guide which shows the work to be carried out on "Minor Service" and "System service".

Correct maintenance is vital to ensure optimum output, reliability and safety.

Operations	Minor Service	System Service
Replace inlet water filter if applicable	Yes	Yes
Check water inlet solenoid valve	Yes	Yes
Clean water inlet solenoid valve	—	Yes
Replace inlet flow restrictor	—	Yes
Check all hoses and connectors	Yes	Yes
Clean inlet valve strainer	—	Yes
Replace all distribution hoses	—	Yes
Check distribution headers	Yes	Yes
Clean distribution headers	—	Yes
Clean pumps & pump housings	—	Yes
Clean front section of tank	Yes	Yes
Clean internal of hydraulic module(s) (use soft cloth only)	Yes	Yes
Check operation of level float and conductivity sensor (if applicable)	Yes	Yes
Clean level float and conductivity sensor	—	Yes
Check droplet separator (if applicable) and evaporator cassettes in suitable condition	Yes	Yes
Lightly brush evaporator cassettes if necessary, replace if heavily soiled	—	Yes
Remove evaporator cassettes and clean all sections of tank and frame structure	—	Yes
Check and secure frame structure and seal	—	Yes
Run unit and check for correct water level	Yes	Yes
Check all media for full saturation	Yes	Yes
Check drain pump operation and correct flow	Yes	Yes
Check operation of all distribution pumps	Yes	Yes
Measure flow rates to distribution headers	—	Yes
Check water temperature and conductivity is within calibration	Yes	Yes
Check and secure all electrical connections	Yes	Yes
Check overall installation for leaks and damage	Yes	Yes
Check software settings	Yes	Yes
Check operation of submerged UV lamps	Yes	Yes
Replace UV lamps	—	Yes
Check any options as per relevant documentation	Yes	Yes
Perform complete disinfection as described in this manual	Yes	Yes
Check safety interlock and temperature control devices	—	Yes
Check air velocity at face of evaporative cassettes matrix	—	recommended
Reset all appropriate maintenance counters	Yes	Yes
Update service log book	Yes	Yes
Add disinfection chemical into the water tank (according to tank volume)	Yes	Yes

## 6.4 Dismantling and installation of components for maintenance

### 6.4.1 Dismantling and installation of the evaporative module



#### WARNING!

In the event of water carry-over from the evaporative cassettes or a water leak, surfaces near the ME evaporative module may have become wet. This could result in a slipping hazard or an increased risk when handling components.

**Prevention:** before carrying out any work on the evaporative module dry all wet surfaces in the AHU/duct.

1. Take the Condair ME Control out of operation as described in [chapter 4.6](#) and allow to drain and dry.
2. Switch the AHU off, and isolate the power and water supply.
3. Disconnect distribution hoses from the connectors on the distribution heads, the wall feed-throughs (if applicable) and the hydraulic module.
4. Remove droplet separator boxes (column by column):
  - Remove upper separator brackets.
  - Remove bank of separator boxes.
  - Remove lower separator brackets.
5. Remove distribution headers assemblies from topmost evaporative cassettes:
  - Undo the clamps fixing the distribution header assembly to the evaporative cassette.
  - Carefully lift off the distribution header assembly.
6. Remove evaporative cassettes (column by column):
  - Push box upwards and remove.
7. Remove optional UV lamp (if applicable).
8. Remove the cross bar (remember position).

Clean dismantled components, water tank, frame structure, blanking plates and air duct as described in [chapter 6.3](#). If all components have been cleaned and dried, assemble the evaporative module in the reverse dismantling order. Replace any defective components with new ones.

## 6.5 Consumables guide

Description	Standard Frequency (month)
Disinfection chemical	1
UV bulb kit	12

Contact your Condair distributor for consumables list/order codes.

To help us ensure that the correct spares parts are sent, please confirm your unit serial and model number with your order.

## 6.6 Routine water sampling and hygiene checks

If regulated by local regulations or by law the water supply quality and the hygiene status of the system must be checked in the prescribed intervals and with the prescribed methods in addition to the periodic system service. The adherence to the local regulations and guidelines as well as the logging of the tests remains in the responsibility of the customer.

If objections are determined, appropriate measures (cleaning and disinfection) are to be initiated.

## 6.7 Cleaning and disinfection

Surface evaporator must be cleaned and serviced in regular intervals, in order to avoid contamination of the system, particularly in industrial environments.

At initial commissioning we recommend the use of the disinfection chemical, which should be placed in the tank and circulated around the system.

Note: Start disinfection process always with the "Start Disinfection" function in the service menu (see [chapter 5.5.2](#)), to prevent the Condair ME Control draining the water tank during the disinfection process.

For systems in operation or where the water quality or air quality is poor, it is recommended to dismantle and scrub the system clean first, then to carry out a disinfection. For this purpose add disinfection chemical into the tank and let the solution circulate for 1 hour minimum (or the time recommended by the disinfectant manufacturer).

All surfaces requiring disinfection or cleaning must be in contact with the appropriate concentration of disinfection solution for the correct contact period. Additional procedures will be required for supply water system pipework or water treatment systems prior to the surface evaporator.

Condair recommends that routine disinfection should take place in the following situations:

- At initial commissioning.
- At six monthly intervals as part of the maintenance regime.
- Before commissioning, if the system or part of it has been shutdown and/or substantially altered creating a risk of contamination.
- During or following any increase of bacterial activity.

## 6.8 Cleaning and disinfection procedure



### WARNING!

Disinfectants can be corrosive, toxic or irritant. Use of disinfectants may present a risk to health and could harm the environment.

---



### WARNING!

The manufacturers safety notes regarding the handling of the disinfection chemical and the neutralising solution used must be observed and followed (e.g. protective clothing and equipment to be used, handling the chemicals, notes on protection of the environment, etc.).

---

#### Step 1 - Preparatory work

- If the Condair ME Control is already in operation, check for correct operation.
- Ensure the Condair ME system and the AHU are OFF and isolated.
- If the system has been without power for more than 48 hours, flush the water supply.
- Ensure the area is well ventilated.
- Refer to the manufacturers instructions and safety advice for the chosen disinfectant.
- If there are concerns over the level of biofilm or bacteria in the system, disinfect the tank before starting cleaning work.
- **Scrub tank fully.** For more thorough disinfection remove droplet separator banks (if applicable) and the evaporative cassettes to allow better access to the tank (refer to maintenance section)
- **Scrub hydraulic module inside fully.** Also scrub inside the pump housings, clean the pump impellers, clean the level sensor, and clean the optional conductivity probe. Take care not to damage the level sensor or conductivity probe.
- Consider appropriate maintenance requirements at this time including parts replacement i.e. replacing distribution hoses to ensure that these are also disinfected.
- Re-assemble the Condair ME system (refer to installation manual).

#### Step 2 - Mix disinfection solution

- Calculate the total water volume of the system.
- Mix disinfection solution following the manufacturers instructions. Check strength of the disinfection solution and ensure it complies with the manufacturers guidelines.



### WARNING!

Disinfectants can be corrosive, toxic or irritant. Use of disinfectants may present a risk to health and could harm the environment.

---



### Step 3 - Run the unit

- Switch the control unit on.
- Send a demand to the unit to start it running (the demand signal can be overridden for the duration of the disinfection using the “Disinfection Demand” function in the service menu (see [chapter 5.5.2](#)).
- Set the duration of the disinfection period using the “Disinfection Duration” function in the service menu (see [chapter 5.5.2](#)). Ensure the disinfection period leaves sufficient time to neutralise the disinfectant if required.
- Start disinfection process always with the “Start Disinfection” function in the service menu (see [chapter 5.5.2](#)), to prevent the Condair ME Control draining the water tank during the disinfection process.
- Check that the evaporative cassettes become fully saturated, and the system is operating correctly.

### Step 4 - Add disinfection solution

- Add the disinfection solution into the water tank for the following circulation process.

### Step 5 - Circulate disinfection solution

- Circulate the disinfection solution in the system. Ensure all surfaces are wetted with the disinfection solution for required time.

### Step 6 - Neutralise the disinfection solution – if required based on manufacturers guidelines of the chemical used



#### WARNING!

If a neutralising solution is required, always ensure that the neutralising solution is used in accordance with the manufacturer’s guidance. Failure to follow the manufacturer’s guidance with regard to neutralising the disinfection chemical may present a risk to health.

- Mix neutralising agent as per manufacturers instructions.
- Allow the neutralising agent to disperse and circulate over the matrix and the tank.
- Measure the strength as per MSDS until the disinfection solution is down to desired strength.

### Step 7 - Drain the unit into foul drain

- Turn Off any fill cycle.
- Drain unit until empty into appropriate drain (check permissibility according to local regulations) and rinse the tank if necessary.
- Fill and drain unit including flushing over the evaporative cassettes and test to ensure that the chemical is removed to the appropriate level.
- Wipe tank clean.
- Where required, reset to original setting and put unit back into operation (according to the notes made in step 3). Test for correct operation as per commissioning section of the manufacturers manual.
- Check for and complete maintenance requirements as per manufacturers instructions.
- Add a mild disinfectant chemical to the tank.
- Always leave work area clean, dry and tidy.

### Step 8 - Re-start the Condair ME system

- Refer to the commissioning section of this manual.

If in doubt always contact your Condair distributor.

## 6.9 Resetting the maintenance indication on Condair ME Control

After completing maintenance work, the maintenance indication or the maintenance counter, respectively must be reset. Proceed as follows to reset the maintenance counter:

1. Select in the "Service" submenu the function "System Service Reset"

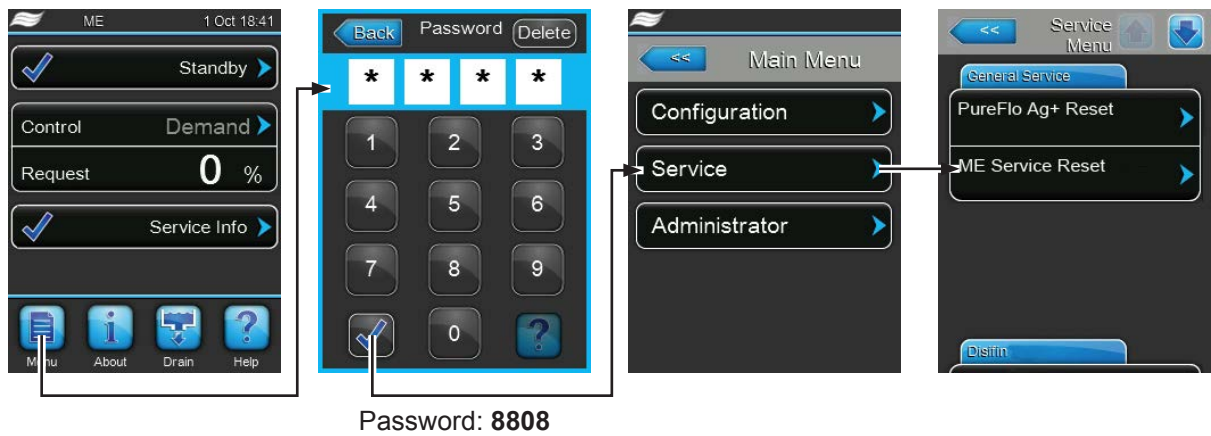

2. The reset dialogue appears in the display:

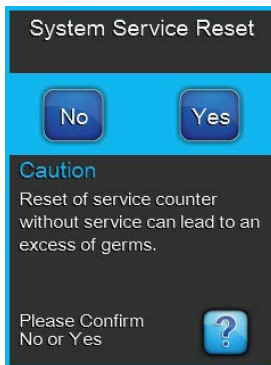

- **If the maintenance work has been completed**, press the **<Yes>** button to reset the **maintenance counter** or the **maintenance indication**, respectively. The **maintenance counter** and the **maintenance indication** are reset and the **control unit** is restarted.
- if the maintenance work has not been completed, press the **<No>** button and you want abort the reset procedure. The control unit returns to the "Service" submenu.

## 6.10 Performing software and firmware updates

To update the control software of the Condair ME Control or the firmware of one of its electronic boards, proceed as follows:

1. Set the **<Control unit On/Off>** switch on the right side of the control unit to the Off position, then switch off the voltage supply to the control unit via the external electrical isolator and secure switch in the Off position to prevent it from inadvertent power up.
2. Unlock the front door of the control unit and remove it.
3. Open control unit inner door.
4. Carefully insert a FAT32 formatted USB memory stick containing the software updates into the USB port on the control board. Make sure that the maximum length of the memory stick does not exceed 75 mm (3").

**Note:** in order to update the control software or the firmware of an electronic board a USB stick with a valid software update (the update files must be on the highest level outside of any folder) must be connected to the USB port on the control board. Otherwise, an appropriate fault message appears when starting the software update.

5. Close control unit inner door, then relocate the front door of the control unit and lock it with the screw.
6. Remove the lock and tag from the external electrical isolator, then switch on to restore power to the control unit.
7. Set the **<Control unit On/Off>** switch on the right side of the control unit to the On position.
8. When the standard operating display appears, select the **<Menu>** button, then enter the password (8808) to login.
9. Select "Administrator > Software Update tab", then select the desired update function:
  - select "**Software Update**" to update the control software,
  - select "**Driver Board A Update**" update the firmware for the driver board,
  - select "**Driver Condu. Update**" update the firmware for the conductivity board.

The update starts. A progress bar is shown in the display. If the update has completed the control unit returns to the standard operating display.



### CAUTION!

Do not interrupt a software or firmware update once it has started. Wait until updating is completed. Corrupted control software or firmware can render the control unit unusable.

**Note:** If software/firmware update is accidentally interrupted, the control unit will not operate, but the software/firmware update can be resumed by leaving the USB key inserted in the control board and power cycling the control unit. The integrated controller will detect the software/firmware was not properly installed, and restart the update.

10. Repeat steps 1 to 3, then carefully remove the USB memory stick.
11. Close control unit inner door, then relocate the front door of the control unit and lock it with the screw.
12. Repeat Step 6 and 7 to power up the control unit.

# 7 Fault elimination

## 7.1 Fault indication on Condair ME Control control unit

Malfunctions during operation detected by the control software are indicated by a corresponding **Warning** message (operation still possible) or **Fault** message (operation no longer possible) in the operating status field in the standard display of the control unit:

### Warning



Temporary problems (e.g. water supply interrupted for a short time) or malfunctions which cannot cause damage to the system are indicated with a warning message. If the cause of the malfunction disappears of its own accord within a certain period of time, the alarm message will automatically switch off otherwise an fault message is triggered.

Note: warnings can be indicated via the service relay of the optional remote operating and fault indication board. The warning indication via the service relay must be activated in the communication menu of the control software (see [chapter 5.4.4](#)) if this functionality is desired.

### Fault



Operational states where further operation is not possible, or where further operation would damage the system are indicated with a fault message. The red fault indicator LED below the touch panel will indicate an active fault on the Condair ME Control. If such a malfunction occurs, the operation of the system is limited only or the Condair ME Control will be **stopped automatically**.

Note: errors can be indicated via the error relay of the optional remote operating and fault indication board.

By pressing on the maintenance and malfunction indication field in the standard operating display the error list shown with all active warning and fault messages. By pressing on the corresponding Warning or Fault entry additional information regarding the malfunction are displayed (see display on the far-right).

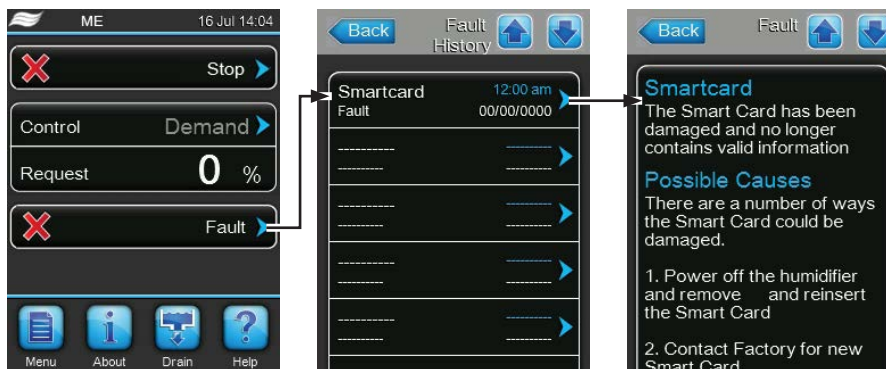

## 7.2 Malfunction list

**Important!** Most operational malfunctions are not caused by faulty equipment but rather by improper installation or disregarding of planning guidelines. Therefore, a complete fault diagnosis always involves a thorough examination of the entire system. Often, the installation of the evaporative module has not been properly executed, or the fault lies with the control system.

Code		Message	Information	
Warning	Fault		Possible causes	Remedy
W01	E01	Smart Card	No communication with SIM card.	
			No SIM card installed.	Contact your Condair representative
			SIM card not valid or defective.	Contact your Condair representative.
W02	—	BMS Timeout	BMS (Modbus, BACnet, LonWorks) has stopped sending demand updates.	
			Signal cable from BMS not connected correctly or defective.	Correctly connect or replace signal cable.
			Interfering signal present.	Eliminate source of interfering signal.
			Address conflict with other units in the chain.	Correctly set unit addresses.
—	E10	CTRL Reset	The control unit (Integrated Controller) has been automatically restarted due to a software problem.	
			The control unit (Integrated Controller) has been automatically restarted due to a software problem	Contact your Condair representative if this problem regularly occurs.
—	E18	Air Temp Snsr	The Condair ME Control stopped operation as the incoming temperature signal of the optional freeze detection sensor has failed. Note: If – at any time – the temperature signal reading is correct again, the system will continue with normal operation.	
			Sensor wiring broken or sensor defective	Check wiring, replace sensor if necessary
			Sensor not connected	Correctly connect sensor to driver board
—	E19	Freeze Prot	The Condair ME stopped operating as the temperature of the incoming air fell below the preset limit of the optional freeze detection. Note: If – at any time – the air temperature of the incoming air rises above the limit value again, the system will continue with normal operation.	
			Temperature too low for safe operation of the Condair ME Control	No remedy
			Temperature limit set wrong	Contact your Condair representative.

Code		Message	Information	
Warning	Fault		Possible causes	Remedy
<b>W20</b>	<b>E20</b>	<b>Safety Chain</b>	The Condair ME Control stopped operating as an external device opened the safety chain. E.g. ventilation Interlock, safety thermostat, etc.. Note: If – at any time – the safety chain is closed again, the system will continue with normal operation.	
			Ventilation interlock open.	If applicable, check/turn on ventilation system.
			Air flow monitor triggered.	Check ventilator/filter of the ventilation system.
			Safety thermostat triggered.	Wait. If applicable, check safety thermostat
<b>W21</b>	—	<b>High Water</b>	Water overflow detected. Current operation status not affected. Note: If – at any time – the normal operating water level is reached, the system will continue with normal operation.	
			Inlet solenoid valve blocked in open position or defective.	Check/replace inlet solenoid valve.
			Gravity drain solenoid valve blocked in closed position.	Check/replace gravity drain solenoid valve.
			Drain piping/drain trap clogged.	Check/Clean drain piping and drain trap.
			Backpressure in drain trap.	Check drain trap venting to duct.
			Assisted drain function not activated.	Contact your Condair representative.
<b>W22</b>	<b>E22</b>	<b>Water Inlet</b>	Tank (re)fill timeout. The Condair ME Control stopped operation as the tank could not be (re)filled within a preset time. The Condair ME Control periodically tries to fill the tank. Note: If – at any time – the required water level is reached, the system will continue with normal operation.	
			Water supply blocked: shut-off valve closed/clogged, water pressure too low.	Check water supply (filter, pipes, etc.), Check/open shut-off valve, Check water pressure.
			Water pressure too low.	Check water supply system.
			Water treatment unit (fully demineralised water) is regenerating.	Wait.
			Inlet solenoid valve blocked or defective.	Check/replace Inlet solenoid valve.
			Gravity drain solenoid valve open, blocked in open position or not electrically connected (currentless open).	Check, electrically connect or replace gravity drain solenoid valve.
			Leakage in the water drain system.	Check/seal water drain system.
<b>W28</b>	<b>E28</b>	<b>ME Service</b>	A warning is triggered if system service interval has exceeded. If the system service is not performed and the system service counter is not reset within 30 days a fault message is triggered. Note: Condair ME Control continues with normal operation.	
			System service is due.	Perform system service and reset system service maintenance counter.
<b>W29</b>	<b>E29</b>	<b>UV Service</b>	A warning is triggered if UV service interval (replacement of UV bulb) has exceeded. If the UV bulb is not replaced and the UV service counter is not reset within 30 days a fault message is triggered. Note: Condair ME Control continues with normal operation.	
			Lifetime of UV bulb(s) (option) expired.	Replace UV bulb(s) and reset UV service counter.

Code		Message	Information	
Warning	Fault		Possible causes	Remedy
	<b>E30</b>	<b>No UV lamp</b>	The Condair ME Control indicates fault as no UV lamp has been detected. Depending on the configuration of the "Shut Down" function (factory level) the Condair ME Control stops or continues operation. The fault message must be reset after elimination of malfunction.	
			UV bulb defective	Replace UV bulb. Reset UV service counter, if all bulbs are replaced.
			UV bulb not wired or wiring broken.	Check wiring/Reconnect UV bulb.
—	<b>E31</b>	<b>UV lamp OC</b>	Current consumption of UV lamp too high. Depending on the configuration of the "Shut Down" function (factory level) the Condair ME Control stops or continues operation. The fault message must be reset after elimination of malfunction.	
			UV bulb broken.	Replace UV bulb. Reset UV service counter, if all bulbs are replaced.
			Short circuit on UV option.	Check wiring.
—	<b>E32</b>	<b>Demand Snsr</b>	Demand signal failed, Condair ME Control automatically stopped operation. Note: If – at any time – the reading of the demand signal is correct again, the system will continue with normal operation.	
			Sensor not connected.	Correctly connect sensor.
			Incorrect sensor configuration.	Correctly configure sensor.
			Sensor defective.	Replace Sensor.
—	<b>E44</b>	<b>Water Temp</b>	Water supply temperature is too high, Condair ME Control changed to "Fill Cycle" mode dilution. The fault message must be reset after elimination of malfunction.	
			Standing Water in inlet system.	Check water supply system.
			Insufficient thermal insulation of inlet pipework.	Insulate supply water pipe.
			Water temperature limit set too low.	Check/adjust water temperature limit.
			Temperature sensor of conductivity sensor configured incorrectly.	Contact your Condair representative.
—	<b>E45</b>	<b>Water Condu</b>	Water supply conductivity is too high, Condair ME Control changed to "Fill Cycle" mode dilution. The fault message must be reset after elimination of malfunction.	
			Water treatment defective/needs service.	Check/service water treatment system.
			Conductivity limit set too low.	Check/adjust Conductivity limit.
			Conductivity sensor configured incorrectly.	Contact your Condair representative.
			Conductivity sensor defective.	Replace conductivity sensor.
—	<b>E46</b>	<b>Water Outlet</b>	Tank drain timeout. The Condair ME Control stopped operation as the tank could not be drained within a preset time. Note: If – at any time – the drain level is reached again, the system will continue with normal operation.	
			Drain pump blocked/defective.	Check/replace drain pump.
			Drain piping or drain trap clogged.	Check/clean drain piping and drain trap.
			Level sensor stucked or short circuited.	Check/replace level sensor.
			Backpressure in drain pipe.	Check drain pipe venting.

Code		Message	Information	
Warning	Fault		Possible causes	Remedy
—	E47	Level Sensor	Water level sensor signal failed. The Condair ME Control stopped operation. Note: If – at any time – the reading of the level sensor is correct again, the system will continue with normal operation.	
			Level sensor not connected.	Correctly connect level sensor.
			Level sensor defective.	Replace level sensor.
—	E48	Water Temp Snsr	Water temperature sensor signal failed, Condair ME Control changed to "Fill Cycle" mode dilution. The fault message must be reset after elimination of malfunction.	
			Water temperature sensor not connected.	Correctly connect water temperature sensor.
			Incorrect water temperature sensor configuration.	Correctly configure water temperature sensor.
			Water temperature sensor defective.	Replace water temperature sensor.
W49	—	Matrix Wash Over	After installation of new evaporative cassettes a wash over procedure needs to be carried out. The wash over is mandatory for evaporative cassettes with glass fibre as evaporator media.	
			Condair ME Control is commissioned first time.	Evaporative cassettes matrix must be washed over with the Matrix wash over function in service submenu.
—	E50	Out of Commissioning	The water held in the supply pipework needs to be fully drained. Any contact with the Condair ME Control has to be avoided.	
			Condair ME Control not energised for more than 48 hours.	Disconnect water supply pipe and flush supply pipe. Reconnect water supply pipe and manually flush the entire water system.
—	E51	Dosing Level	Level in the liquid tank of the optional system for enhancing polyester media water absorption too low. Current operation status not affected.	
			Liquid used up during normal operation.	Refill liquid.
			Incorrect floater connection.	Check/correctly connect floater.
			Floater defective.	Replace floater sensor.
—	E54	Standing WTR	Standing water outside the tank detected. The Condair ME Control stopped operating as a leak of the tank or pipework has been detected.	
			Water leakage on evaporative module or water piping inside the duct.	Check system and seal any leaky components.
—	E70	Water Condu Snsr	Water conductivity sensor signal failed, Condair ME Control changed to "Fill Cycle" mode dilution. The fault message must be reset after elimination of malfunction.	
			Water conductivity sensor not connected.	Correctly connect water conductivity sensor.
			Incorrect water conductivity sensor configuration.	Contact your Condair representative.
			Water conductivity sensor defective.	Replace water conductivity sensor.
—	E74	Keep Alive	Faulty communication, Condair ME Control automatically stopped operation. The fault message must be reset after elimination of malfunction.	
			Driver board not connected.	Correctly connect driver board.
			Wrong driver board connected.	Connect correct driver board.
			Driver board defective.	Replace driver board.



Code		Message	Information	
Warning	Fault		Possible causes	Remedy
—	E82	Driver Missing	Communication with driver board failed, Condair ME Control automatically stopped operation. The fault message must be reset after elimination of malfunction.	
			RS485 Bus to driver board interrupted.	Contact your Condair representative.
—	E83	Slave Address	Slave address changed during operation, Condair ME Control automatically stopped operation. The fault message must be reset after elimination of malfunction.	
			Wrong driver address.	Check that each driver board connected to one controller has a different address.
—	E84	Driver faulty	Unspecific driver board fault, Condair ME Control automatically stopped operation. The fault message must be reset after elimination of malfunction.	
			Driver board defective.	Replace driver board.
—	E85	Driver ID Wrong	Driver board ID wrong, Condair ME Control automatically stopped operation. The fault message must be reset after elimination of malfunction.	
			Wrong driver board connected or SAB address wrong.	Contact your Condair representative.
—	E86	Driver Incompatible	Version of driver board doesn't match, Condair ME Control automatically stopped operation. The fault message must be reset after elimination of malfunction.	
			Wrong version of driver board.	Contact your Condair representative.
—	E87	Local 24V Supply	Local 24V supply out of valid range, Condair ME Control automatically stopped operation. The fault message must be reset after elimination of malfunction.	
			Fuses on driver board defective.	Check fuses on driver board and replace.
			Short circuit in control panel.	Check control panel.
			Switched power supply unit defective.	Check/replace switched power supply unit.
—	E88	Local 5V Supply	Local 5V supply out of valid range, Condair ME Control automatically stopped operation. The fault message must be reset after elimination of malfunction.	
			Fuses on driver board defective.	Check fuses on driver board and replace.
			Short circuit in control panel.	Check control panel.
			Switched power supply unit defective.	Check/replace switched power supply unit.
—	E89	Local Ref Supply	Local reference supply out of valid range, Condair ME Control automatically stopped operation. The fault message must be reset after elimination of malfunction.	
			Driver Board defective.	Replace driver board.
—	E96	Peri. 5V Supply	Peripheral 5V supply out of valid range, Condair ME Control automatically stopped operation. The fault message must be reset after elimination of malfunction.	
			Fuses on driver board defective.	Check fuses on driver board and replace.
			Short circuit in control panel.	Check control panel.
			Switched power supply unit defective.	Check/replace switched power supply unit.
—	E100	IO Inlet	The smart output driver detected short circuit or open load on the output of the inlet valve.	
			Inlet valve defective.	Replace inlet valve.
			Distribution board defective.	Replace distribution board.
			Inlet valve not connected.	Correctly connect inlet valve

Code		Message	Information	
Warning	Fault		Possible causes	Remedy
	<b>E103 to E109</b>	<b>IO Stage x (e.g. IO Stage 1)</b>	The smart output driver detected short circuit or open load on the output of the corresponding stage pump.	
			Corresponding stage pump defective.	Replace corresponding stage pump.
			Distribution board defective.	Replace distribution board.
			Corresponding stage pump not connected.	Correctly connect corresponding stage pump.
	<b>E110</b>	<b>IO Drain</b>	The smart output driver detected short circuit or open load on the output of the drain valve.	
			Drain valve defective.	Replace corresponding drain valve.
			Distribution board defective.	Replace distribution board.
			Drain valve not connected.	Correctly connect drain valve.
	<b>E111</b>	<b>IO Drain Pump</b>	The smart output driver detected short circuit or open load on the output of the drain pump.	
			Drain pump defective.	Replace drain pump.
			Distribution board defective.	Replace distribution board.
			Drain pump not connected.	Correctly connect drain pump.
—	<b>E129 (Pump 1) and E132 (Pump 2) to E137 (Pump 7)</b>	<b>Pump Error</b>	The controller was not able to activate one or more stage pumps. The Condair ME Control will continue to attempt normal operation. The fault message must be reset after elimination of malfunction.	
			Stage fault detection option not correctly installed.	Contact your Condair representative.
			Electrical pump connection broken.	Electrically connect or replace respective pump.
			Pump impeller Worn.	Replace pump impeller.
			Pump defective.	Replace defective pump.

### 7.3 Saving fault and service histories to a USB memory stick

The fault and service histories of the Condair ME Control can be saved to a USB memory stick for logging and further analysis. For this purpose proceed as follows:

1. Set the **<Control unit On/Off>** switch on the right side of the control unit to the Off position, then switch off the voltage supply to the control unit via the external electrical isolator and secure switch in the Off position to prevent it from inadvertent power up.
2. Unlock the front door of the control unit and remove it.
3. Open control unit inner door.
4. Carefully insert a FAT32 formatted USB memory stick into the USB port on the control board. Make sure that the maximum length of the memory stick does not exceed 75 mm (3").
5. Close control unit inner door, then relocate the front door of the control unit and lock it with the screw.
6. Remove the lock and tag from the external electrical isolator, then switch on to restore power to the control unit.
7. Set the **<Control unit On/Off>** switch on the right side of the control unit to the On position.
8. When the standard operating display appears, select the **<Menu>** button, then enter the password (8808) to login.
9. Select **"Service > Fault/Service History tab > Export History"**. The last 40 fault and service history events of the Condair ME Control are then downloaded to the memory stick as separate .csv files labelled "WARNING\_FAULT.csv" and "SERVICE\_HISTORY.csv".  
Note: the CSV tables can be processed with a spread-sheet program on a PC
10. Repeat steps 1 to 3, then carefully remove the USB memory stick.
11. Close control panel assembly, then close the door panel of the control compartment and lock it with the screw.
12. Repeat Step 6 and 7 to power up the control unit.

### 7.4 Malfunctions without indication

Malfunction	Cause	Remedy
<b>Residual water in the section of the duct downstream of the evaporative module.</b>	Face velocity is too high.	Install droplet separator or reduce air velocity in the duct.
	Water tank, water piping or hydraulic module is leaking.	Check/seal water tank, water piping and hydraulic module.
	Water flow to media too high.	Check duty in software is correct, then adjust pump calibration as required.
	Evaporative cassettes have become blocked with minerals.	Check set up, replace evaporative cassettes, perform system service.
	Uneven or non laminar air flow.	Check design conditions of AHU. Install perforated plate on the air supply side.
	Air on temperature is too low.	Check design conditions of AHU. and increase temperature.

Malfunction	Cause	Remedy
Cooling demand present however the Condair ME Control does not cool.	Shut-off valve in the water supply line closed.	Open shut-off valve.
	Site control are not correct.	Prove controls and control module.
Maximum cooling capacity is not reached.	Insufficient water supply capacity.	Check water supply, increase water pressure.
	Evaporative cassettes have become blocked with minerals.	Check set up, replace evaporative cassettes, perform system service.

## 7.5 Notes on fault elimination

- For the elimination of faults set the Condair ME out of operation as described in [chapter 4.6](#), disconnect control unit from the mains and close shut-off valve in the water supply line.



### DANGER!

Make sure the control unit is separated from the mains (check with voltage detector) and the shut-off valve in the water supply line is closed.

- The elimination of faults must be carried out by qualified and well trained professionals only. Malfunctions relating to the electrical installation (e.g. replacement of the backup battery, replacement of fuses) must be repaired by authorized personnel (e.g. licensed electrician). or by your Condair representative's service technician only.



### CAUTION!

Electronic components are very sensitive to electrostatic discharge. When carrying out repairs to the control unit, appropriate measures (ESD-protection) must be taken to prevent damage to electronic components.

- Repair work and the replacement of faulty components must be carried out by your Condair representative's service technician only!

## 7.6 Resetting the fault status on Condair ME Control

To reset the error indication:

1. Disconnect the control unit of the Condair ME Control from the mains.
2. Wait approx. 5 seconds, then reconnect the control unit to the mains.

Note: If the fault has not been eliminated, the fault indication reappears after a short while.

## 7.7 Replacing the fuses and backup battery in the control unit

The fuses of the control unit must be replaced by **authorized personnel only** (e.g. electrician).

Replace fuses of the control unit only with fuses matching the specifications below with the appropriate nominal current capacity. Never use refurbished fuses. Do not bridge the fuse holder.

To replace the fuses or the backup battery proceed as follows:

1. Disconnect control unit from the mains by switching off the electrical isolator and secure electrical isolator in "Off" position against inadvertent switching on.
2. Undo the screw of the front cover of the control unit, then remove the front cover.
3. Open control unit inner door.
4. Replace desired fuse or the backup battery.



**DANGER!**

Fuse contact protection must be relocated after the fuse has been replaced.

5. Close control unit inner door.
6. Relocate front cover on control unit and lock it with the retaining screw.
7. Reconnect control to the mains by switching on the electrical isolator.

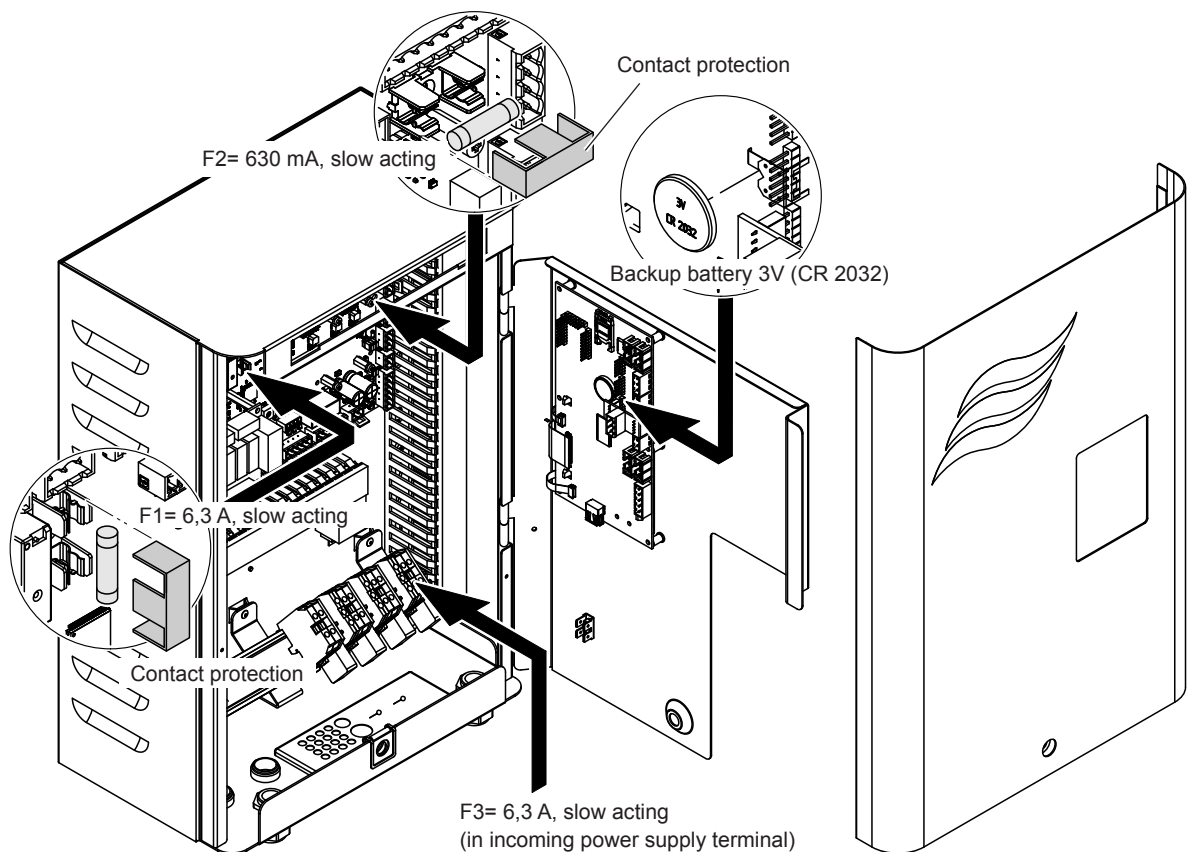

Fig. 11: Replacing the fuses and backup battery in the control unit

## 8 Taking out of service/Disposal

---

### 8.1 Taking out of service

If the Condair ME Control must be replaced or if the Condair ME Control is not needed any more, proceed as follows:

1. Take the Condair ME Control out of operation as described in [chapter 4.6](#).
2. Have the system components unmounted by a qualified service technician.

### 8.2 Disposal/Recycling

Components not used any more must not be disposed of in the domestic waste. Please dispose of the individual components in accordance with local regulations at the authorised collecting point.

If you have any questions, please contact the responsible authority or your local Condair representative.

Thank you for your contribution to environmental protection.

## 9 Product specifications

### 9.1 Technical data

	Condair ME Control
Supply voltage control unit	100...240 VAC/50...60 Hz
Supply voltage circulation pumps	24 VDC (supplied by control unit)
Power consumption <sup>1)</sup>	< 278 W (5 stages, no options fitted)
Control signals	0...5 VDC 1...5 VDC 0..10 VDC 2...10 VDC 0...16 VDC 3.2...16 VDC 0..20 mA 4..20 mA On/Off (via potential-free contact)
Control accuracy with stage control	Control accuracy depends on air conditions, control distance, water quality, number of stage pumps and on the number of On/Off cycles
Max. admissible matrix face velocity	3.5 m/s <b>without</b> droplet separator 4.5 m/s <b>with</b> droplet separator
Supply water connector	Compression fitting ø15 mm
Water drain connectors (outside diameter)	Tank: ø50 mm Hydraulic module: ø32 mm
Admissible water supply pressure	2...5 bar
Admissible water temperature	5...20 °C
Required supply water quality	Tap water, softened or fully demineralised water with a max. of 100 cfu/ml
Admissible operating air temperature	10...60 °C
Admissible ambient temperature (Control unit)	1...40 °C
Admissible ambient humidity (Control unit)	max. 75 %rh
Degree of protection of Control unit	IP21
Degree of protection of Hydraulic module	IP42
Conformity	CE marking
Fire classification of evaporative media	glass fibre media: A2-S2,-D0 (UL Class 1) polyester media: DIN EN 53438 Class F1

<sup>1)</sup> Power consumption depending on the number of vertical evaporative cassettes banks and the options fitted

# 10 Appendix

## 10.1 Wiring diagram Condair ME Control

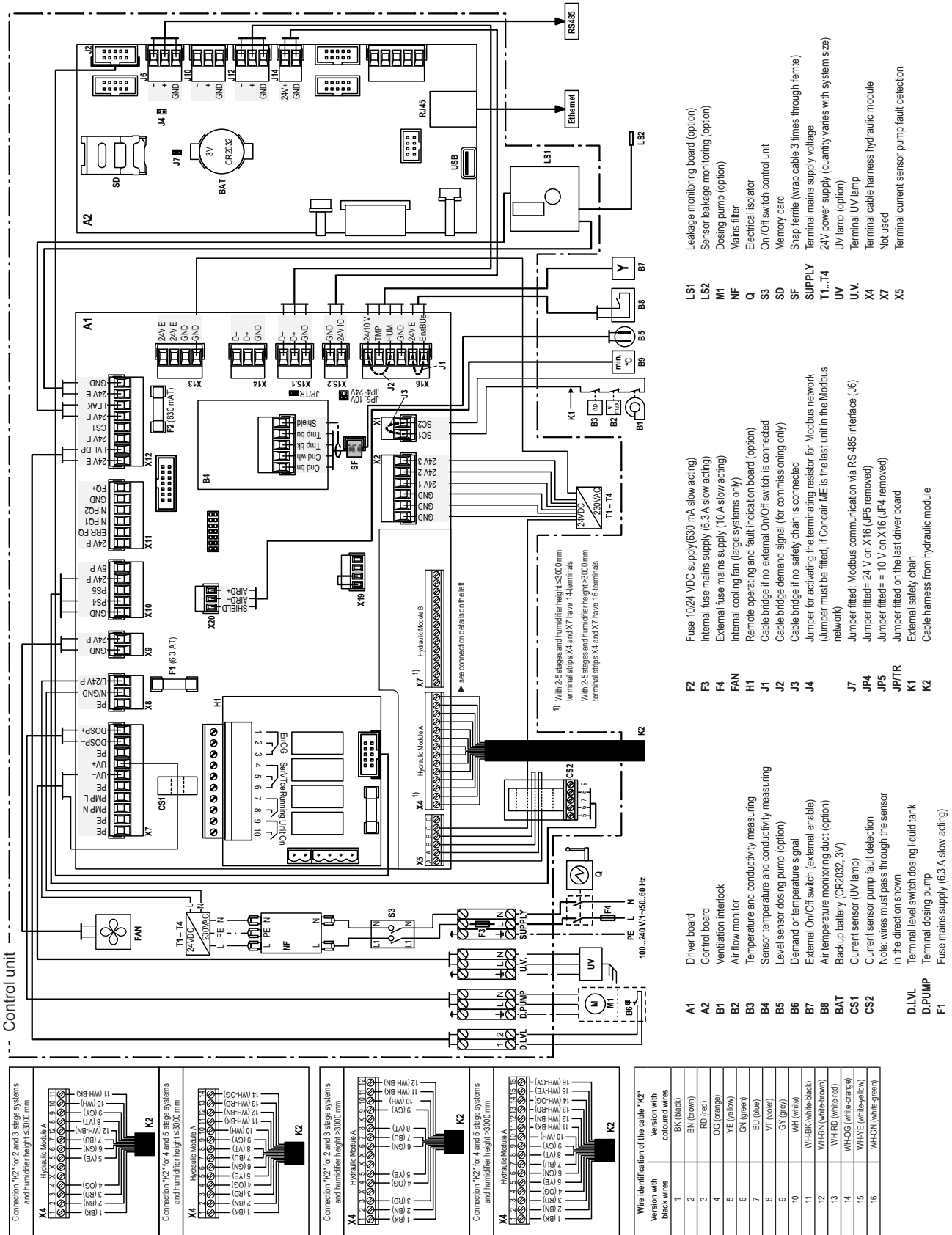



**Notes**

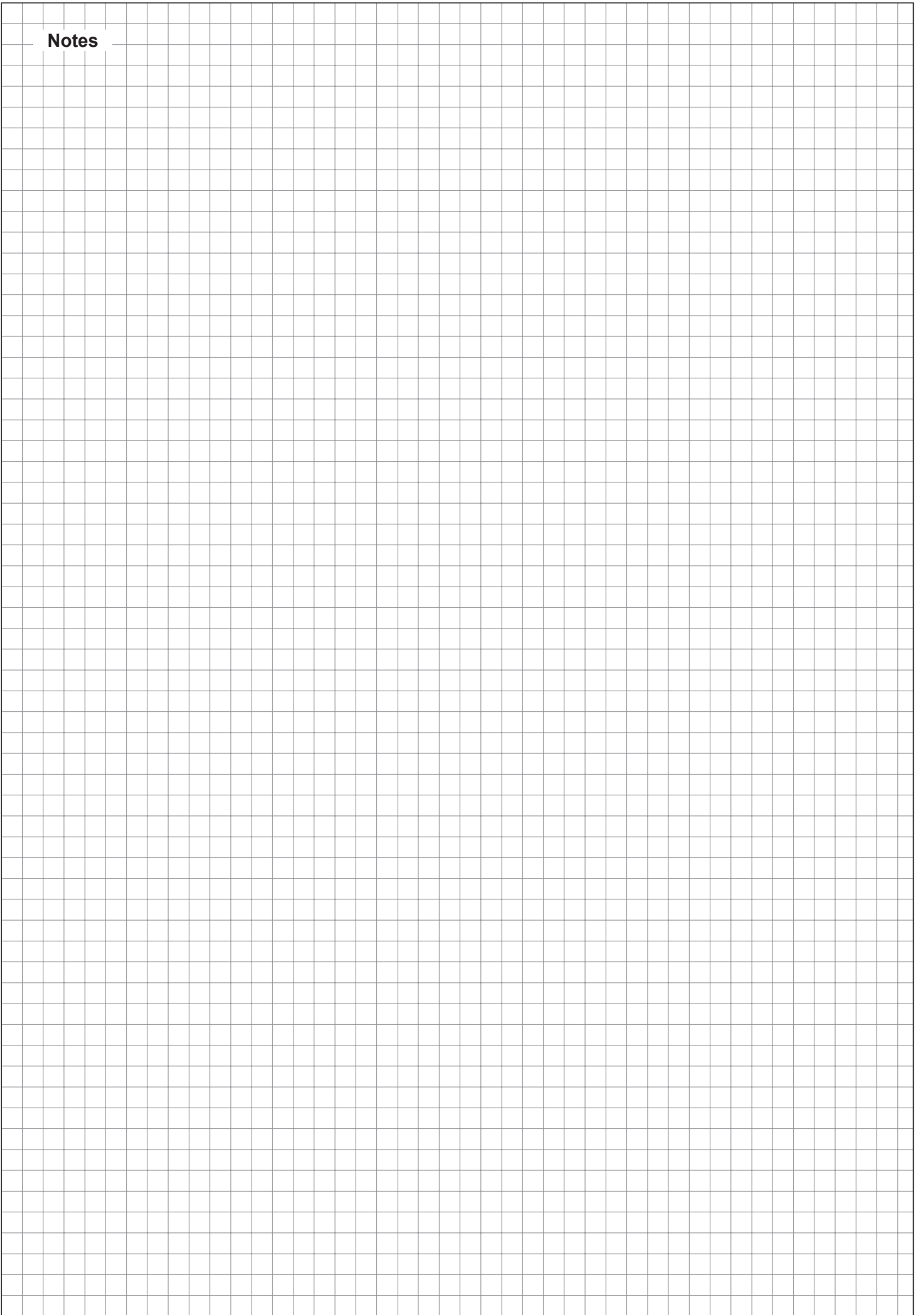

Notes

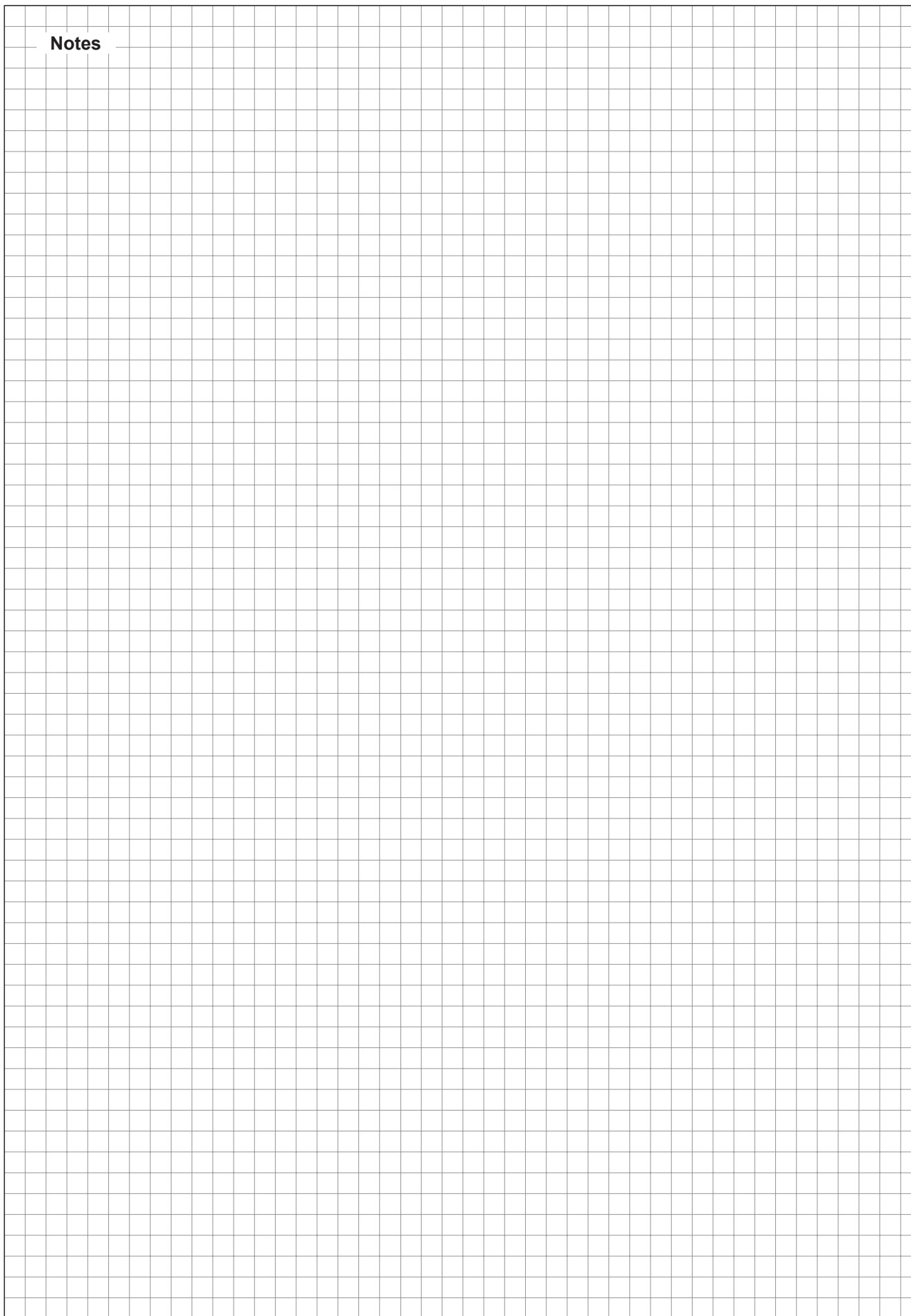



CONSULTING, SALES AND SERVICE:



CH94/0002.00

Condair Group AG  
Gwattstrasse 17, 8808 Pfäffikon SZ, Switzerland  
Phone +41 55 416 61 11, Fax +41 55 588 00 07  
info@condair.com, www.condairgroup.com

The Condair logo, consisting of a stylized wave symbol followed by the word 'condair' in a bold, lowercase, sans-serif font.